

STORMWATER TECHNICAL STANDARDS
MANUAL
FRANKLIN COUNTY, INDIANA

TABLE OF CONTENTS

| <i>Chapter</i> | <i>Title</i> |
|----------------|---|
| 1 | INTRODUCTION |
| 2 | METHODOLOGY FOR DETERMINATION OF RUNOFF RATES |
| 3 | METHODOLOGY FOR DETERMINATION OF RETENTION/DETENTION STORAGE VOLUMES |
| 4 | STORM SEWER DESIGN STANDARDS AND SPECIFICATIONS |
| 5 | OPEN CHANNEL DESIGN STANDARDS AND SPECIFICATIONS |
| 6 | STORMWATER DETENTION DESIGN STANDARDS FOR PEAK FLOW CONTROL |
| 7 | LOT/BUILDING GRADING AND DRAINAGE STANDARDS |
| 8 | RIVER CORRIDOR, BLUFFS, AND FLOODPLAIN PROTECTION STANDARDS |
| 9 | STANDARDS ASSOCIATED WITH DAMS AND LEVEES |
| 10 | SPECIAL STANDARDS FOR PROPOSED SOLAR FARMS |
| | APPENDIX A : ABBREVIATIONS AND DEFINITIONS |
| | APPENDIX B : STANDARD FORMS |



Chapter One

INTRODUCTION

This document, the *Franklin County* Stormwater Technical Standards Manual, contains the necessary technical standards for administering the requirements of the *Franklin County* Stormwater Management Ordinance. This document should be considered as a companion document to the Ordinance. Whereas the Ordinance contains the majority of the regulatory authority and general requirements of comprehensive stormwater management, this document contains the necessary means and methods for achieving compliance with the Ordinance. In case there are conflicts between the requirements contained in this document and the ordinance, the requirements of the Ordinance should prevail.

Chapters 2 through 6 contain stormwater conveyance and detention calculations.

Chapter 7 contains standards regarding lot/building developments, including grading and building pad elevations, acceptable outlet and adjoining property impact requirements. Chapter 8 contains river corridor, bluffs, and floodplain protection standards. Chapter 9 covers standards associated with proposed new or improvements to existing dams or levees as well as proposed developments downstream of existing dams. Chapter 10 contains special stormwater standards associated with proposed solar farms. A comprehensive glossary of terms is provided in Appendix A. Appendix B contains several useful and necessary standard forms.

The *Franklin County* Stormwater Management Ordinance and this Technical Standards Manual provide the general requirements and recommended/acceptable methods for design and review of stormwater quantity and quality infrastructure within *Franklin County*. For a comprehensive technical guidance on calculations and modeling of stormwater quantity and quality infrastructure in Indiana, refer to the latest edition of the "Indiana LTAP Stormwater Drainage Manual".



Chapter Two

METHODOLOGY FOR DETERMINATION OF RUNOFF RATES

Runoff rates shall be computed for the area of the parcel under development plus the area of the watershed flowing into the parcel under development. The rate of runoff which is generated as the result of a given rainfall intensity may be calculated as follows:

A. DEVELOPMENT SITES LESS THAN OR EQUAL TO 5 ACRES IN SIZE, WITH A CONTRIBUTING DRAINAGE AREA LESS THAN OR EQUAL TO 25 ACRES AND NO DEPRESSIONAL STORAGE

The Rational Method may be used. A computer model, such as TR-55 (NRCS), TR-20 (NRCS), HEC-HMS (COE), and HEC-1 (COE), that can generate hydrographs based on the NRCS TR-55 time of concentration and curve number calculation methodologies may also be used along with a 24-hour duration NRCS Type 2 storm. Note that for the purpose of determining the post-developed conditions curve numbers, due to significant disturbance to the upper soil layers during the construction activities, the initially determined hydrologic soil group for disturbed areas should be changed to the next less infiltrating capacity category (i.e., A to B, B to C, and C to D).

In the Rational Method, the peak rate of runoff, Q , in cubic feet per second (cfs) is computed as:

$$Q = CIA$$

Where: C = Runoff coefficient, representing the characteristics of the drainage area and defined as the ratio of runoff to rainfall.

I = Average intensity of rainfall in inches per hour for a duration equal to the time of concentration (t_c) for a selected rainfall frequency.

A = Tributary drainage area in acres.

Values for the runoff coefficient "C" are provided in **Tables 2-1** and **2-2**, which show values for different types of surfaces and local soil characteristics. The composite "C" value used for a given drainage area with various surface types shall be the weighted average value for the total area calculated from a breakdown of individual areas having different surface types. **Table 2-3** provides runoff coefficients and inlet times for different land use classifications.

Rainfall intensity shall be determined from the rainfall frequency data shown in **Table 2-4**.

In general, the time of concentration (t_c) methodology to be used for all stormwater management projects within *Franklin County* shall be as outlined in the U.S. Department of Agriculture (USDA) -

NRCS TR-55 Manual. In urban or developed areas, the methodology to be used shall be the sum of the inlet time and flow time in the stormwater facility from the most remote part of the drainage area to the point under consideration. The flow time in the storm sewers may be estimated by the distance in feet divided by velocity of flow in feet per second. The velocity shall be determined by the Manning's Equation (see Chapter 4). Inlet time is the combined time required for the runoff to reach the inlet of the storm sewer. It includes overland flow time and flow time through established surface drainage channels such as swales, ditches, and sheet flow across such areas as lawns, fields, and other graded surfaces.

TABLE 2-1

| Urban Runoff Coefficients | | | | |
|---|--|----------------|----------------|-----------------|
| <i>Type of Surface</i> | <i>Runoff Coefficient "C" (by Storm Recurrence Interval)</i> | | | |
| | <i>< 25 year</i> | <i>25 year</i> | <i>50 year</i> | <i>100 year</i> |
| <input type="checkbox"/> Hard Surfaces | | | | |
| Asphalt | 0.82 | 0.90 | 1.00 | 1.00 |
| Gravel | 0.85 | 0.94 | 1.00 | 1.00 |
| Concrete | 0.85 | 0.94 | 1.00 | 1.00 |
| Roof | 0.85 | 0.94 | 1.00 | 1.00 |
| <input type="checkbox"/> Lawns (Sandy) | | | | |
| Flat (0-2% Slope) | 0.07 | 0.08 | 0.09 | 0.12 |
| Rolling (2-7% Slope) | 0.12 | 0.13 | 0.16 | 0.20 |
| Steep (Greater than 7% Slope) | 0.17 | 0.19 | 0.22 | 0.28 |
| <input type="checkbox"/> Lawns (Clay) | | | | |
| Flat (0-2% Slope) | 0.16 | 0.18 | 0.21 | 0.26 |
| Rolling (2-7% Slope) | 0.21 | 0.23 | 0.28 | 0.35 |
| Steep (Greater than 7% Slope) | 0.30 | 0.33 | 0.40 | 0.50 |

Source: HERPICC Stormwater Drainage Manual, July 1995, and other sources.

TABLE 2-2

| Rural Runoff Coefficients | | | | |
|--|--|----------------|----------------|-----------------|
| <i>Type of Surface</i> | <i>Runoff Coefficient "C" (by Storm Recurrence Interval)</i> | | | |
| | <i>< 25 year</i> | <i>25 year</i> | <i>50 year</i> | <i>100 year</i> |
| <input type="checkbox"/> Woodland (Sandy) | | | | |
| Flat (0-2% Slope) | 0.10 | 0.11 | 0.13 | 0.17 |
| Rolling (2-7% Slope) | 0.25 | 0.28 | 0.33 | 0.41 |
| Steep (Greater than 7% Slope) | 0.30 | 0.33 | 0.40 | 0.50 |
| <input type="checkbox"/> Woodland (Clay) | | | | |
| Flat (0-2% Slope) | 0.30 | 0.33 | 0.40 | 0.50 |
| Rolling (2-7% Slope) | 0.35 | 0.39 | 0.46 | 0.58 |
| Steep (Greater than 7% Slope) | 0.50 | 0.55 | 0.66 | 0.83 |
| <input type="checkbox"/> Pasture (Sandy) | | | | |
| Flat (0-2% Slope) | 0.10 | 0.11 | 0.13 | 0.17 |
| Rolling (2-7% Slope) | 0.16 | 0.18 | 0.21 | 0.26 |
| Steep (Greater than 7% Slope) | 0.22 | 0.24 | 0.29 | 0.36 |
| <input type="checkbox"/> Pasture (Clay) | | | | |
| Flat (0-2% Slope) | 0.30 | 0.33 | 0.40 | 0.50 |
| Rolling (2-7% Slope) | 0.36 | 0.40 | 0.48 | 0.59 |
| Steep (Greater than 7% Slope) | 0.42 | 0.46 | 0.55 | 0.69 |
| <input type="checkbox"/> Cultivated (Sandy) | | | | |
| Flat (0-2% Slope) | 0.30 | 0.33 | 0.40 | 0.50 |
| Rolling (2-7% Slope) | 0.40 | 0.44 | 0.53 | 0.66 |
| Steep (Greater than 7% Slope) | 0.52 | 0.57 | 0.69 | 0.86 |
| <input type="checkbox"/> Cultivated (Clay) | | | | |
| Flat (0-2% Slope) | 0.50 | 0.55 | 0.66 | 0.83 |
| Rolling (2-7% Slope) | 0.60 | 0.66 | 0.79 | 0.99 |
| Steep (Greater than 7% Slope) | 0.72 | 0.79 | 0.95 | 1.00 |

Source: HERPICC Stormwater Drainage Manual, July 1995, and other sources.

TABLE 2-3

| Runoff Coefficients by Land Use, Typical Inlet Times, and Storm Recurrence Interval | | | | | | | | | | | | | |
|--|---|--------------------|--------------------|---------------------|-------------------------|--------------------|--------------------|---------------------|-------------------------|--------------------|--------------------|---------------------|---|
| <i>Land Use</i> | <i>Runoff Coefficients "C" (by Storm Recurrence Interval)</i> | | | | | | | | | | | | <i>Inlet Time (Minutes) (4)</i> |
| | Flat (1) | | | | Rolling (2) | | | | Steep (3) | | | | |
| | <i>< 25 year</i> | <i>25 year</i> | <i>50 year</i> | <i>100 year</i> | <i>< 25 year</i> | <i>25 year</i> | <i>50 year</i> | <i>100 year</i> | <i>< 25 year</i> | <i>25 year</i> | <i>50 year</i> | <i>100 year</i> | |
| Commercial (CBD) | 0.75 | 0.83 | 0.99 | 1.00 | 0.83 | 0.91 | 1.00 | 1.00 | 0.91 | 1.00 | 1.00 | 1.00 | 5 |
| Commercial (Neighborhood) | 0.54 | 0.59 | 0.71 | 0.89 | 0.60 | 0.66 | 0.79 | 0.99 | 0.66 | 0.73 | 0.87 | 1.00 | 5 - 10 |
| Industrial | 0.63 | 0.69 | 0.83 | 1.00 | 0.70 | 0.77 | 0.92 | 1.00 | 0.77 | 0.85 | 1.00 | 1.00 | |
| Garden Apartments | 0.54 | 0.59 | 0.71 | 0.89 | 0.60 | 0.66 | 0.79 | 0.99 | 0.66 | 0.73 | 0.87 | 1.00 | |
| Churches | 0.54 | 0.59 | 0.71 | 0.89 | 0.60 | 0.66 | 0.79 | 0.99 | 0.66 | 0.73 | 0.87 | 1.00 | |
| Schools | 0.31 | 0.34 | 0.41 | 0.51 | 0.35 | 0.39 | 0.46 | 0.58 | 0.39 | 0.43 | 0.51 | 0.64 | 10 - 15 |
| Semi Detached Residential | 0.45 | 0.50 | 0.59 | 0.74 | 0.50 | 0.55 | 0.66 | 0.83 | 0.55 | 0.61 | 0.73 | 0.91 | |
| Detached Residential | 0.40 | 0.44 | 0.53 | 0.66 | 0.45 | 0.50 | 0.59 | 0.74 | 0.50 | 0.55 | 0.66 | 0.83 | |
| Quarter Acre Lots | 0.36 | 0.40 | 0.48 | 0.59 | 0.40 | 0.44 | 0.53 | 0.66 | 0.44 | 0.48 | 0.58 | 0.73 | |
| Half Acre Lots | 0.31 | 0.34 | 0.41 | 0.51 | 0.35 | 0.39 | 0.46 | 0.58 | 0.39 | 0.43 | 0.51 | 0.64 | |
| Parkland | 0.18 | 0.20 | 0.24 | 0.30 | 0.20 | 0.22 | 0.26 | 0.33 | 0.22 | 0.24 | 0.29 | 0.36 | To be Computed |

Source: HERPICC Stormwater Drainage Manual, July 1995, and other sources.

- Notes:** (1) Flat terrain involves slopes of 0-2%.
(2) Rolling terrain involves slopes of 2-7%.
(3) Steep terrain involves slopes greater than 7%.
(4) Interpolation, extrapolation and adjustment for local conditions shall be based on engineering experience and judgment.

B. DEVELOPMENT SITES GREATER THAN 5 ACRES IN SIZE OR CONTRIBUTING DRAINAGE AREA GREATER THAN 25 ACRES OR WITH SIGNIFICANT DEPRESSIONAL STORAGE

The runoff rate for these development sites and contributing drainage areas shall be determined by a computer model that can generate hydrographs based on the NRCS TR-55 time of concentration and curve number calculation methodologies. Note that for the purpose of determining the post-developed conditions curve numbers, due to significant disturbance to the upper soil layers during the construction activities, the initially determined hydrologic soil group for disturbed areas should be changed to the next less infiltrating capacity category (i.e., A to B, B to C, and C to D).

The 24-hour NRCS Type 2 Rainfall Distribution shall be utilized for runoff calculations. 24-hour Rainfall depth for various frequencies shall be taken from **Table 2-5**.

The NRCS Type 2 distribution ordinates are found in **Table 2-6**. This table should be used only when the rainfall distribution is not a default option in the computer program. Examples of computer models that can generate such hydrographs include TR-55 (NRCS), TR-20 (NRCS), and HEC-HMS (COE). These programs may be downloaded free of charge from the associated agencies' web sites. Other models may be acceptable on a case by case basis.

TABLE 2-4

| Rainfall Intensities for Various Return Periods and Storm Durations | | | | | | |
|---|-------------------------|---|----|----|----|-----|
| Duration | Intensity (Inches/Hour) | | | | | |
| | Return Period (Years) | | | | | |
| | 2 | 5 | 10 | 25 | 50 | 100 |
| 5 min | | | | | | |
| 10 min | | | | | | |
| 15 min | | | | | | |
| 30 min | | | | | | |
| 1 hr | | | | | | |
| 2 hr | | | | | | |
| 3 hr | | | | | | |
| 6 hr | | | | | | |
| 12 hr | | | | | | |
| 24 hr | | | | | | |

Source: NOAA, National Weather Service, "Precipitation-Frequency Atlas of the United States", NOAA Atlas 14, Volume 2, Version 3, rev 2006, for [your location], Indiana. (values for intermediate durations can be logarithmically interpolated.) (All rainfall intensities are based on Annual Maximum series)

TABLE 2-5

| Rainfall Depths for Various Return Periods | | | | | | | |
|--|-----------------------|---|---|----|----|----|-----|
| Duration | Depth (Inches) | | | | | | |
| | Return Period (Years) | | | | | | |
| | 1 | 2 | 5 | 10 | 25 | 50 | 100 |
| 24 Hrs. | | | | | | | |

Source: NOAA, National Weather Service, "Precipitation-Frequency Atlas of the United States", NOAA Atlas 14, Volume 2, Version 2, rev 2006, for [your location], Indiana. (Rainfall depths for 2-through 100-year storm are based on annual maximum series. 1-year rainfall depth is based on partial duration series)

The values for tables 2-4 and 2-5 should be obtained for a central location within the Franklin County by accessing the following site:

https://hdsc.nws.noaa.gov/hdsc/pfds_map_cont.html?bkmrk=in

To account for near future conditions, the upper bound of the 90% confidence interval values provided underneath each intensity and depth value entry in the Atlas 14 table is recommended to be used instead of the default 50% values.

TABLE 2-6

| NRCS Type II Rainfall Distribution Ordinates | | | | | |
|---|--|-----------------------------------|--|-----------------------------------|--|
| <i>Cumulative Storm Time (hr)</i> | <i>Cumulative Percent of Storm Depth</i> | <i>Cumulative Storm Time (hr)</i> | <i>Cumulative Percent of Storm Depth</i> | <i>Cumulative Storm Time (hr)</i> | <i>Cumulative Percent of Storm Depth</i> |
| 0.00 | 0 | 8.25 | 12.6 | 16.50 | 89.3 |
| 0.25 | 0.2 | 8.50 | 13.3 | 16.75 | 89.8 |
| 0.50 | 0.5 | 8.75 | 14 | 17.00 | 90.3 |
| 0.75 | 0.8 | 9.00 | 14.7 | 17.25 | 90.8 |
| 1.00 | 1.1 | 9.25 | 15.5 | 17.50 | 91.3 |
| 1.25 | 1.4 | 9.50 | 16.3 | 17.75 | 91.8 |
| 1.50 | 1.7 | 9.75 | 17.2 | 18.00 | 92.2 |
| 1.75 | 2 | 10.00 | 18.1 | 18.25 | 92.6 |
| 2.00 | 2.3 | 10.25 | 19.1 | 18.50 | 93 |
| 2.25 | 2.6 | 10.50 | 20.3 | 18.75 | 93.4 |
| 2.50 | 2.9 | 10.75 | 21.8 | 19.00 | 93.8 |
| 2.75 | 3.2 | 11.00 | 23.6 | 19.25 | 94.2 |
| 3.00 | 3.5 | 11.25 | 25.7 | 19.50 | 94.6 |
| 3.25 | 3.8 | 11.50 | 28.3 | 19.75 | 95 |
| 3.50 | 4.1 | 11.75 | 38.7 | 20.00 | 95.3 |
| 3.75 | 4.4 | 12.00 | 66.3 | 20.25 | 95.6 |
| 4.00 | 4.8 | 12.25 | 70.7 | 20.50 | 95.9 |
| 4.25 | 5.2 | 12.50 | 73.5 | 20.75 | 96.2 |
| 4.50 | 5.6 | 12.75 | 75.8 | 21.00 | 96.5 |
| 4.75 | 6 | 13.00 | 77.6 | 21.25 | 96.8 |
| 5.00 | 6.4 | 13.25 | 79.1 | 21.50 | 97.1 |
| 5.25 | 6.8 | 13.50 | 80.4 | 21.75 | 97.4 |
| 5.50 | 7.2 | 13.75 | 81.5 | 22.00 | 97.7 |
| 5.75 | 7.6 | 14.00 | 82.5 | 22.25 | 98 |
| 6.00 | 8 | 14.25 | 83.4 | 22.50 | 98.3 |
| 6.25 | 8.5 | 14.50 | 84.2 | 22.75 | 98.6 |
| 6.50 | 9 | 14.75 | 84.9 | 23.00 | 98.9 |
| 6.75 | 9.5 | 15.00 | 85.6 | 23.25 | 99.2 |
| 7.00 | 10 | 15.25 | 86.3 | 23.50 | 99.5 |
| 7.25 | 10.5 | 15.50 | 86.9 | 23.75 | 99.8 |
| 7.50 | 11 | 15.75 | 87.5 | 24.00 | 100 |
| 7.75 | 11.5 | 16.00 | 88.1 | | |
| 8.00 | 12 | 16.25 | 88.7 | | |

Source: National Resources Conservation Service (NRCS), "TR-20 Computer Program for Project Formulation Hydrology", page F9, May 1982.

NOTE: For use only when SCS Type II rainfall distribution is not a default option in the computer program.

C. DEVELOPMENT SITES WITH DRAINAGE AREAS GREATER THAN OR EQUAL TO ONE SQUARE MILE

For the design of any major drainage system, as defined in **Appendix A**, the discharge must be obtained from, or be accepted by, the IDNR. Other portions of the site must use the discharge methodology in the applicable section of this Chapter.



Chapter Three

METHODOLOGY FOR DETERMINATION OF RETENTION/DETENTION STORAGE VOLUMES

The required volume of stormwater storage for all development sites shall be computed using a computer model that can generate hydrographs based on the NRCS TR-55 time of concentration and curve number calculation methodologies. Examples of computer models that can generate such hydrographs include TR-55 (NRCS), TR-20 (NRCS), and HEC-HMS (COE). Other models may be acceptable on a case by case basis.

A. POST-DEVELOPMENT HYDROLOGIC PARAMETERS

Note that for the purpose of determining the post-developed conditions curve numbers, due to significant disturbance to the upper soil layers during the construction activities, the initially determined hydrologic soil group for disturbed areas should be changed to the next less infiltrating capacity category (i.e., A to B, B to C, and C to D).

B. DESIGN STORM & ALLOWABLE RELEASE RATES FOR DEVELOPMENT SITES WITH ON-SITE DETENTION FACILITIES

The 24-hour NRCS Type 2 Rainfall Distribution shall be utilized to determine the required storage volume. The allowable release rates shall be determined based on methodologies provided in Chapter 6 of these Technical Standards document.

C. DESIGN STORM & ALLOWABLE RELEASE RATES FOR DEVELOPMENT SITES WITHIN A DESIGNATED DRAINAGE AREA SERVICED BY A REGIONAL DETENTION FACILITY

Development sites within Designated Drainage Areas making use of regional detention ponds are typically not required to provide on-site detention.

Where a regional detention facility is servicing or is planned to service a sub-watershed area, and that sub-watershed has been declared a Designated Drainage Area to raise the necessary Infrastructure Development Fees in lieu of providing on-site detention, the following method shall be used to determine the size of storage space that would have been required on-site. This estimated storage volume will be used to determine the fee based on the development site's proportionate share of regional detention storage.

The 24-hour NRCS Type 2 Rainfall Distribution shall be utilized to determine the required storage volume. The stormwater model should not include an on-site detention facility. The outflow hydrograph at the downstream-most point in the site's stormwater system shall be compared to the allowable release rate for the Designated Drainage Area to determine the required storage volume. The allowable release rate for a Designated Drainage Area shall be as defined by the resolution forming the Designated Drainage Area.

The storage volume shall be determined by calculating the volume of outflow from the site that exceeds the given allowable release rate. For example, if a 50-acre site is located in a Designated Drainage Area that has an allowable post-development 100-year release rate of 0.2 cfs/acre, the required storage volume for the site would be equal to the volume of water represented by the cross-hatched area in **Figure 3-1**.

FIGURE 3-1
Required Storage Volume Determination Example

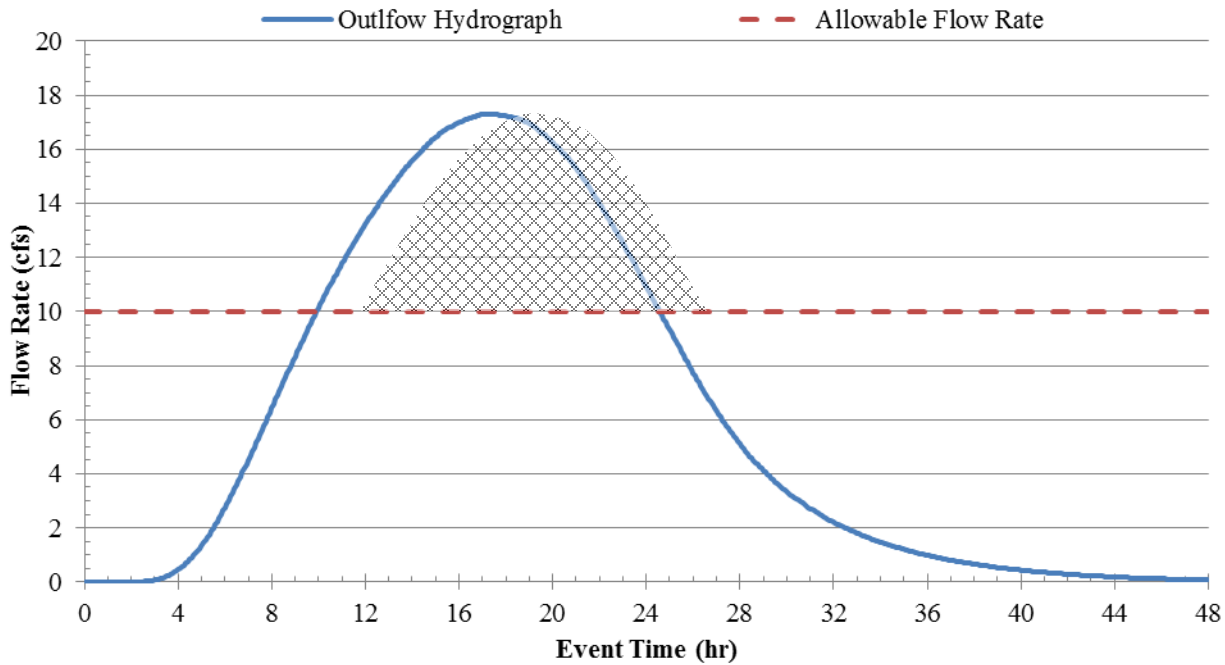



Chapter Four

STORM SEWER DESIGN STANDARDS AND SPECIFICATIONS

All storm sewers, whether private or public, and whether constructed on private or public property shall conform to the design standards and other requirements contained herein. Proposed storm sewer systems must be sized and designed to convey at least the 10-year frequency on-site stormwater runoff, as well as the anticipated 10-year frequency tributary off-site stormwater runoff based on the future developed condition (using Table 6-1 of the Technical Standards). An analysis of the emergency routing of stormwater runoff through the subject development must be provided to confirm that the development will not obstruct the free flow of floodwaters from the tributary off-site property in its current condition and after development. In addition, the Drainage System Overflow Design must be completed in accordance with Section M of this chapter to ensure the safe routing of flood waters through the subject development with the tributary off-site property in its current condition and after development.

A. DESIGN STORM FREQUENCIES

1. All storm sewers, inlets, catch basins, and street gutters shall accommodate (subject to the “allowable spread” provisions discussed later in this Section), as a minimum, peak runoff from a 10-year return frequency storm calculated based on methodology described in Chapter 2. Additional discharges to storm sewer systems allowed in Section L below of this Section must be considered in all design calculations.
2. Culvert capacities for conveyance under interior local, collector, or arterial streets without roadway overtopping shall be the runoff resulting from the 25-year, 50-year, and 100-year frequency storms, respectively, for off-site areas under existing condition and on-site areas under post-developed conditions. Driveway culvert capacities shall be capacities required for the street classification to which the driveway connects. Greater culvert capacity shall be required to protect the finished floor elevation of buildings from the post-developed 100-year frequency storm when, in the opinion of the design engineer or Franklin County, the finished floor elevation is threatened. If the street or road provides the only access to or from any portion of any commercial or residential development, the crossing shall be designed for a minimum of 100-year frequency storm.
3. For portions of the system considered minor drainage systems, the allowable spread of water on Collector Streets for the design storm is limited to maintaining two clear 10-foot moving lanes of traffic. One lane is to be maintained on Local Roads, while other access lanes (such as a subdivision cul-de-sac) can have a water spread equal to one-half of their total width.
4. To ensure access to buildings and allow the use of the roadway by emergency vehicles during storms larger than the design storm, an overflow channel/swale between sag inlets and overflow paths or basin shall be provided at sag inlets so that the maximum depth of water that might be ponded in the street sag shall not exceed 7 inches measured from elevation of gutter. All water shall be contained in the right-of-way for a 100-year storm.

5. Facilities functioning as a major drainage system as defined in **Appendix A** must also meet IDNR design standards in addition to Franklin County standards. In case of discrepancy, the most restrictive requirements shall apply.
6. New drain tiles and pipes, smaller than 24 inches in diameter, shall be placed in a 20-foot easement (10 feet from centerline on each side) and shall be designated on the record plat as 20-foot Regulated Drain Easement. Pipes that are 24 inches or larger in diameter, shall be placed in a 30-foot easement (15 feet from centerline on each side) and shall be designated on the record plat as 30-foot Regulated Drain Easement. Wider easements may be required by Franklin County or designee when the depth of pipe is greater than 6 to 10 feet, depending on the pipe size.

B. DETERMINATION OF HYDRAULIC CAPACITY FOR STORM SEWERS USING MANNING'S EQUATION

Determination of hydraulic capacity for storm sewers sized by the Rational Method analysis must be done using Manning's Equation. where:

$$V = (1.486/n)(R^{2/3})(S^{1/2})$$

Then:

$$Q=(V)(A)$$

Where:

- Q = capacity in cubic feet per second
- V = mean velocity of flow in feet per second
- A = cross sectional area in square feet
- R = hydraulic radius in feet
- S = slope of the energy grade line in feet per foot
- n = Manning's "n" or roughness coefficient

The hydraulic radius, R, is defined as the cross-sectional area of flow divided by the wetted flow surface or wetted perimeter. Allowable "n" values and full-flow maximum permissible velocities for storm sewer materials are listed in **Table 4-1**.

TABLE 4-1

| Typical Values of Manning's "n" | | |
|---|----------------------|---|
| <i>Material</i> | <i>Manning's "n"</i> | <i>Maximum Velocities (feet/second)</i> |
| ☐ Closed Conduits | | |
| Concrete | 0.013 | 10 |
| Vitrified Clay | 0.013 | 10 |
| HDPE & Polypropylene | 0.012 | 10 |
| PVC | 0.012 | 10 |
| ☐ Circular CMP, Annular Corrugations, 2 2/3 x 1/2 inch | | |
| Unpaved | 0.024 | 7 |
| 25% Paved | 0.021 | 7 |
| 50% Paved | 0.018 | 7 |
| 100% Paved | 0.013 | 7 |
| Concrete Culverts | 0.013 | 10 |
| HDPE or PVC | 0.012 | 10 |
| ☐ Open Channels | | |
| Concrete, Trowel Finish | 0.013 | 10 |
| Concrete, Broom Finish | 0.015 | 10 |
| Gunite | 0.018 | 10 |
| Riprap Placed | 0.030 | 10 |
| Riprap Dumped | 0.035 | 10 |
| Gabion | 0.028 | 10 |
| New Earth (1) | 0.025 | 4 |
| Existing Earth (2) | 0.030 | 4 |
| Dense Growth of Weeds | 0.040 | 4 |
| Dense Weeds and Brush | 0.040 | 4 |
| Swale with Grass | 0.035 | 4 |

Source of manning "n" values: HERPICC Stormwater Drainage Manual, July 1995.

- (1) New earth (uniform, sodded, clay soil)
- (2) Existing earth (fairly uniform, with some weeds).

C. BACKWATER METHOD FOR PIPE SYSTEM ANALYSIS

For hydraulic analysis of existing or proposed storm drains which possess submerged outfalls, a more sophisticated design/analysis methodology than Manning's equation will be required. The backwater analysis method provides a more accurate estimate of pipe flow by calculating individual head losses in pipe systems that are surcharged and/or have submerged outlets. These head losses are added to a known downstream water surface elevation to give a design water surface elevation for a given flow at the desired upstream location.

Tailwater conditions assumed for this computation should be verified by appropriate calculations. Total head losses may be determined as follows:

Total head loss = frictional loss + manhole loss + velocity head loss + junction loss

Various computer modeling programs such as HYDRA, ILLUDRAIN, and STORMCAD are available for analysis of storm drains under these conditions. Computer models to be utilized, other than those listed, must be accepted by Franklin County or designee.

D. MINIMUM SIZE FOR STORM SEWERS

The minimum diameter of all storm sewers shall be 12 inches. When the minimum 12-inch diameter pipe will not limit the rate of release to the required amount, the rate of release for detention storage shall be controlled by an orifice plate or other device, subject to acceptance of Franklin County.

E. PIPE COVER, GRADE, AND SEPARATION FROM SANITARY SEWERS

Pipe grade shall be such that, in general, a minimum of 2.0 feet of cover is maintained over the top of the pipe. If the pipe is to be placed under pavement, or within 5 feet of the pavement, then the minimum pipe cover shall be 2.5 feet from top of pavement to top of pipe. Uniform slopes shall be maintained between inlets, manholes and inlets to manholes. Final grade shall be set with full consideration of the capacity required, sedimentation problems, and other design parameters. Minimum and maximum allowable slopes shall be those capable of producing velocities of between 2.5 and 10 feet per second, respectively, when the sewer is flowing full. Maximum permissible velocities for various storm sewer materials are listed in **Table 4-1**. A minimum of 2.0 feet of vertical separation between storm sewers and sanitary sewers shall be required. When this is not possible, the sanitary sewer must be encased in concrete or ductile steel within 5 feet, each side, of the crossing centerline.

F. ALIGNMENT

Storm sewers shall be straight between manholes and/or inlets.

G. MANHOLES/INLETS

Manholes and/or inlets shall be installed to provide human access to continuous underground storm sewers for the purpose of inspection and maintenance. The casting access minimum inside diameter shall be no less than 22 inches or a rectangular opening of no less than 22 inches by 22 inches. Steps shall be provided in structures deeper than 4 feet, with the first step at the depth of 2 feet and the following steps spaced every 1 foot until the bottom is reached. When grade adjustments of manholes and inlets are required in the field to meet finish design or existing curb grade, adjustment rings with a maximum height of 12 inches may be used. Manholes shall be provided at the following locations:

1. Where two or more storm sewers converge.
2. Where pipe size or the pipe material changes.
3. Where a change in horizontal alignment occurs.
4. Where a change in pipe slope occurs.
5. At intervals in straight sections of sewer, not to exceed the maximum allowed. The maximum distance between storm sewer manholes shall be as shown in **Table 4-2**.

TABLE 4-2

| Maximum Distance Between Manholes | |
|-----------------------------------|-------------------------|
| Size of Pipe (Inches) | Maximum Distance (Feet) |
| 12 through 42 | 400 |
| 48 and larger | 600 |

Manhole/inlet inside sizing shall be according to the *Franklin County* Standard Construction Details.

In addition to the above requirements, a minimum drop of 0.1 foot through manholes and inlet structures should be provided. When changing pipe size, match crowns of pipes, unless detailed modeling of hydraulic grade line shows that another arrangement would be as effective. Pipe slope should not be so steep that inlets surcharge (i.e. hydraulic grade line should remain below rim elevation).

Plans should note that all Inlets and castings must be pre-stamped with a “clean water” message.

Manhole/inlet inside sizing shall be as shown in **Table 4-3**.

TABLE 4-3

| Manhole/Inlet Inside Sizing | | |
|------------------------------------|-------------------------|-------------------------------|
| Depth of Structure | Minimum Diameter | Minimum Square Opening |
| Less than 5 feet | 36 inches | 36" x 36" |
| 5 feet or more | 48 inches | 48" x 48" |

H. INLET SIZING AND SPACING

Inlets or drainage structures shall be utilized to collect surface water through grated openings and convey it to storm sewers, channels, or culverts. The inlet grate opening provided shall be adequate to pass the design 10-year flow with 50% of the sag inlet areas clogged. Inlets shall be provided so that surface water is not carried across or around any intersection nor for a distance greater than five hundred (500) feet. An overflow channel from sag inlets to the overflow channel or basin shall be provided at sag inlets. Inlet design and spacing may be done using the hydraulic equations by manufacturers or orifice/weir equations. Use of the U.S. Army Corps of Engineers HEC-12 computer program is also an acceptable method. Gutter spread on continuous grades may be determined using the Manning's equation, or by using **Figure 4-1**. Further guidance regarding gutter spread calculation may be found in the latest edition of LTAP Stormwater Drainage Manual, available from the Local Technical Assistance Program (LTAP). At the time of printing of this document, contact information for LTAP was:

Indiana LTAP
Purdue University
Toll-Free: (800) 428-7369 (Indiana only)
Phone: (765) 494-2164
Fax: (765) 496-1176
Email: inltap@ecn.purdue.edu
Website: www.purdue.edu/INLTAP/

I. INSTALLATION AND WORKMANSHIP

The point of commencement for laying a storm sewer pipe shall be the lowest point in the proposed sewer line. All pipes shall be laid, without break, upgrade from structure to structure. All storm sewer pipe outlets shall have poured in place toewalls with anchor bolts. Bedding and backfill materials around storm sewer pipes, sub-drains, and the associated structures shall be per Figures 4-2 and 4-3. The specific location requirements for the use of these materials are dependent on pipe location in relation to pavement structures and on pipe material as detailed in **Figure 4-2** and **Figure 4-3**. The specifications for the construction of storm sewers and sub-drains, including backfill requirements, shall not be less stringent than those set forth in the latest edition of the INDOT "Standard Specifications". Additionally, ductile iron pipe shall be laid in accordance with American Water Works Association (AWWA) C-600 and clay pipe shall be laid in accordance with

either American Society of Testing Materials (ASTM) C-12 or the appropriate American Association of State Highway and Transportation Officials (AASHTO) specifications.

Dips/sags on newly installed storm systems will not be allowed. Also, infiltration from cracks, missing pieces, and joints would not be allowed. Variations from these standards must be justified and receive written acceptance from Franklin County. To verify that all enclosed drains and sewers are functioning properly, all storm sewers including sub-drains shall be cleaned and televised with visual recordings (via closed circuit television). Two visual recordings will be scheduled, 30 days after installation and at least 90 days prior to the expiration of the maintenance bond. Reports summarizing the results of the noted visual recordings shall be reviewed and accepted by Franklin County before maintenance sureties would be recommended to be released.

Based on the review of visual recordings, Franklin County shall determine the need for additional inspection of the storm sewers or sub-drains to assess the condition of the system. Newly installed storm systems covered under the maintenance bond shall meet the minimum requirements established in the AASHTO Culvert and Storm Drain Inspection Guide constituting a Condition Rating of 1 or "Good" as defined in Section 4, Condition Rating System and as established below in **Table 4-4**.

TABLE 4-4

| Pipe Inspection Criteria | |
|---------------------------------|--|
| <i>Material</i> | <i>(1) Good Rating Condition</i> |
| HDPE, PVC or PP | Barrel maintains round shape with less than 5% vertical deformation of original ID. No indication of wear, abrasion, splits or cracking. |
| Concrete | No measurable crack width greater than 0.01 in. No spalling, slabbing, delamination, scaling or abrasion. |
| CMP | Barrel maintains round shape with less than 5% vertical deformation of inside diameter. No dents, rust, abrasion or localized damage. |

J. MATERIALS

Storm sewer manholes and inlets shall be constructed of cast in place concrete or pre-cast reinforced concrete. Material and construction shall conform to the latest edition of the Indiana Department of Transportation (INDOT) "Standard Specifications", Sections 702 and 720.

Pipe and fittings used in storm sewer construction shall conform to the latest edition of the INDOT "Standard Specifications", Section 907 and 908. In addition, ductile iron pipe and fittings shall conform to AWWA C-151. Polyethylene pipe used for private storm sewers shall conform to ASTM F2648 or INDOT specifications. Other pipe and fittings not specified herein or in Sections 907-908

of the latest edition of the INDOT “Standard Specifications” may be used only when specifically authorized by Franklin County. Pipe joints shall be flexible and leak resistant as defined in AASHTO R82, with a maximum leakage rate of 200 gal/in.-dia/mi/day. **If the storm sewer pipe is to be placed within a road right-of-way or in an area subject to loading, the pipe and fittings shall be reinforced concrete (RCP) or corrugated polypropylene (CPP).**

K. SPECIAL HYDRAULIC STRUCTURES

Special hydraulic structures required to control the flow of water in storm runoff drainage systems include junction chambers, drop manholes, stilling basins, and other special structures. The use of these structures shall be limited to those locations justified by prudent planning and by careful and thorough hydraulic engineering analysis. Certification of special structures by a certified Structural Engineer may also be required.

L. CONNECTIONS TO STORM SEWER SYSTEM

To allow any connections to the storm sewer system, provisions for the connections shall be shown in the drainage calculations for the system. Specific language shall be provided in the protective covenants, on the record plat, or with the parcel deed of record, noting the ability or inability of the system to accommodate any permitted connections, for example, sump pumps and footing drains.

1. **Sump pumps** installed to receive and discharge groundwater or other stormwater shall be connected to a sub-surface drain provided by the developer. Sump pumps installed to receive and discharge floor drain flow or other sanitary sewage shall be connected to the sanitary sewers. A stormwater sump pump shall only be used for the discharge of stormwater.
2. **Footing drains and perimeter drains** shall be connected to the sub-surface drain provided by the developer.
3. All **roof downspouts**, roof drains, or roof drainage piping of residential developments shall discharge onto a grass surface that is no closer than 25 feet to the right-of-way of any street and shall not be directly connected to the storm drainage system. Variation from this requirement may be requested and granted by Franklin County in special circumstances. No downspouts or roof drains shall be connected to the public sanitary sewers.

Commercial, industrial, and institutional buildings that have their own private storm sewers may direct such drains directly to their systems.

4. **Garage and Basement floor drains** shall not be connected to the storm sewers.
5. **Swimming Pool drains** shall not be connected to the storm sewers unless the water is dechlorinated, as defined in Appendix A, prior to being connected to the storm sewer.

In addition, none of the above-mentioned drains shall be connected to any road sub-drain/street underdrains, unless requested as a variance and specifically authorized by Franklin County. Sub-drains shall be installed on all new developments by the developer.

M. DRAINAGE SYSTEM OVERFLOW DESIGN

Overflow path/ponding areas throughout the development resulting from a 100-year storm event, calculated based on all contributing drainage areas, on-site and off-site, in their proposed or reasonably anticipated land use and with storm pipe system assumed completely plugged, shall be determined,

The centerline of this 100-year overflow path shall be clearly shown as a distinctive line symbol on the plans, and a minimum width of 30 feet flow width along the centerline of the flow path (15 feet from centerline on each side) designated as permanent drainage easements. A continuous flood route from the sag inlets to the final outfall shall be shown and the minimum 30-feet along the centerline contained within an easement or road right-of-way regardless of the 100-year storm event ponding elevation. This overflow path/easement area shall be shown on the plans as hatched area or another distinctive symbol. No fences or landscaping should be constructed within the easement areas. These areas are easements that are to be maintained by the property owners or be designated as common areas to be maintained by the homeowners association.

The minimum adjacent grade of the portion of any residential, commercial, or industrial building (the ground elevation next to the building after construction is completed that sits adjacent to the emergency flood route or may be subject to flooding by the emergency flood route) shall be a minimum of 1 foot above the estimated 100-year elevation of the emergency flood route assuming that all stormwater pipes are fully clogged. The required minimum adjacent grade of buildings adjacent to an overflow path is provided in **Table 4-5** or as alternatively calculated as discussed below.

TABLE 4-5

| Minimum Building Adjacent Grade with Respect to Overflow Path Invert Elevations | | |
|--|--|---|
| Drainage Area (Acres) | Minimum Building Adjacent Grade Above Overflow Path Invert (Feet)¹ | Minimum Building Adjacent Grade Above Overflow Path Invert, if Overflow Path is in the Street (Feet)¹ |
| Up to 5 | 2.50 | 1.50 |
| 6-10 | 3.00 | 1.50 |
| 11-15 | 3.25 | 1.75 |
| 16-20 | 3.50 | 1.75 |

| | | | |
|-------|------|------|----------------------------|
| 21-30 | 4.00 | 2.00 | Notes: ¹ The |
| 30-50 | 4.25 | 2.00 | |

overflow path Invert refers to the elevation of the flow line of the emergency flow route (typically in the form of a channel, swale, or gutter) nearest to the upstream end of a building

As an alternative to using default values in Table 4-5, the overflow path/ponding may be modeled as successive series of natural ponds and open channel segments. For simplification, occasional ponding along the overflow path may be ignored. If explicitly modeled, ponds should be modeled similar to that discussed for modeling depressional areas in Chapter 6. Channels should be modeled according to modeling techniques discussed in Chapter 5. The calculations for determining the 100-year overflow path/ponding elevations may be based on hand calculation methods utilizing normal depth calculations and storage routing techniques or performed by computer models. Examples of computer models that either individually or in combination with other models can handle the required computations include TR-20 and HEC-HMS, combined with HEC-RAS. Other models may be acceptable on a case by case basis.

Simply using the values in Table 4-5 is preferred over the much more complicated detailed modeling of the overflow/ponding areas. However, regardless of the methodology used, Franklin County reserves the right to require independent calculations to verify that the proposed building minimum adjacent grade facing the flood route or the portion of building having a potential to be subject to flooding by the flood route provide adequate freeboard above the anticipated overflow path/ponding elevations.

The Lowest Adjacent Grade (LAG) requirements for buildings adjacent to other flooding sources are discussed in Chapter 7 of this Manual. In case there are more than one flooding sources applicable to a building site, the highest calculated LAG for the building shall govern the placement of the building on that site

In the case of existing upstream detention, an allowance equivalent to the reduction in flow rate provided may be made for upstream detention only when: (1) such detention and release rate have previously been accepted by Franklin County or other official charged with the approval authority at the time of the acceptance, and (2) evidence of its construction and maintenance can be shown.

FIGURE 4-1
Street and Gutter Capacities (continuous grade)

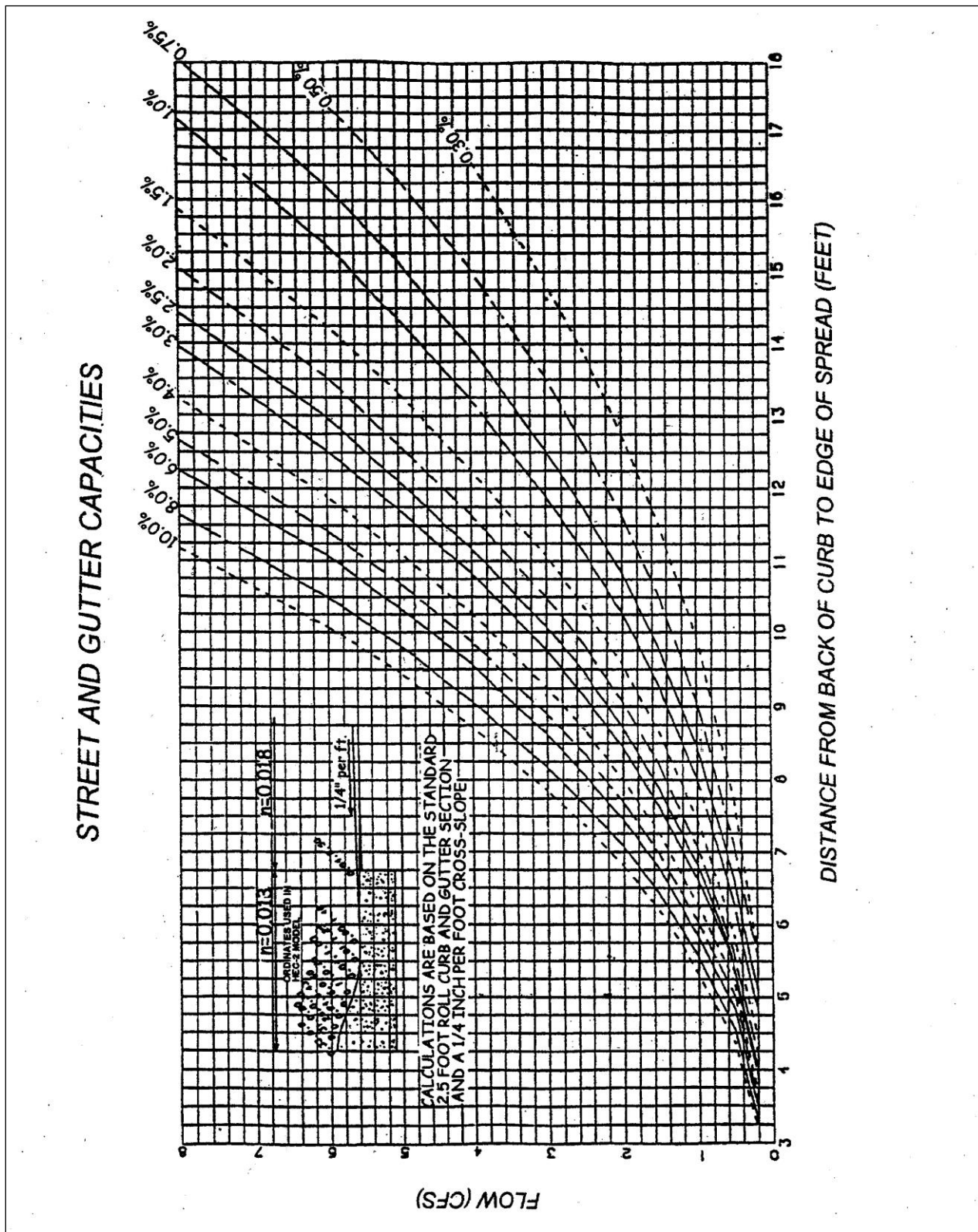

**FIGURE 4-2
Bedding and Backfill Standards for Storm Sewers**

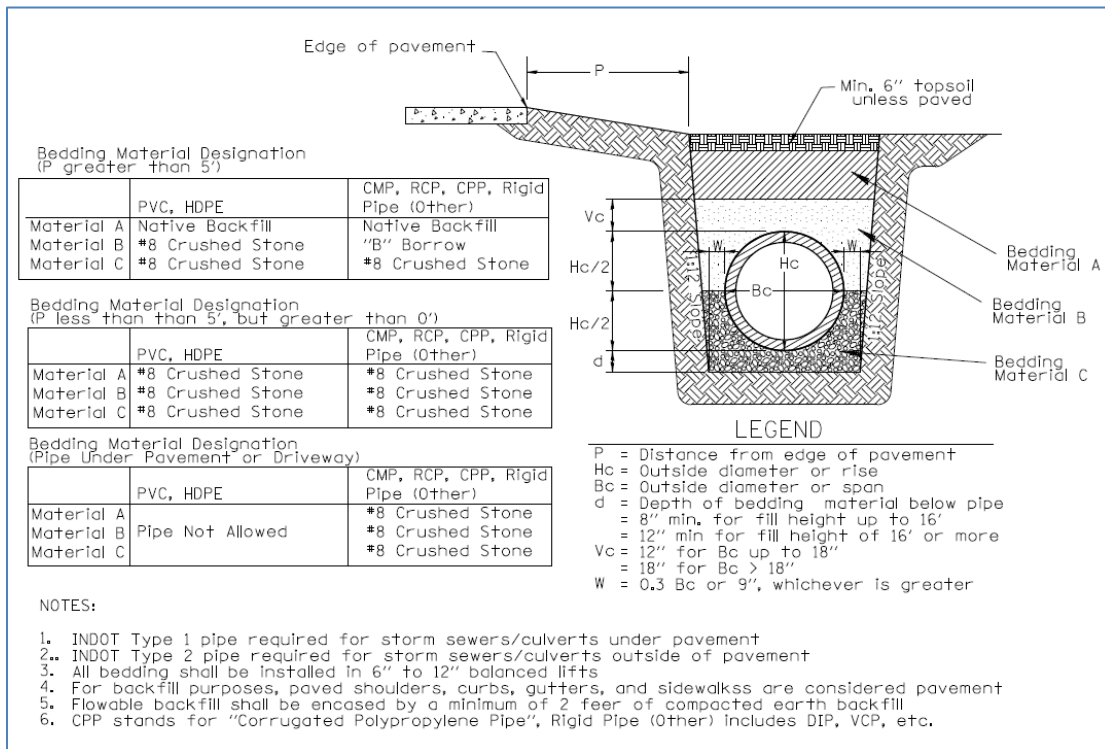
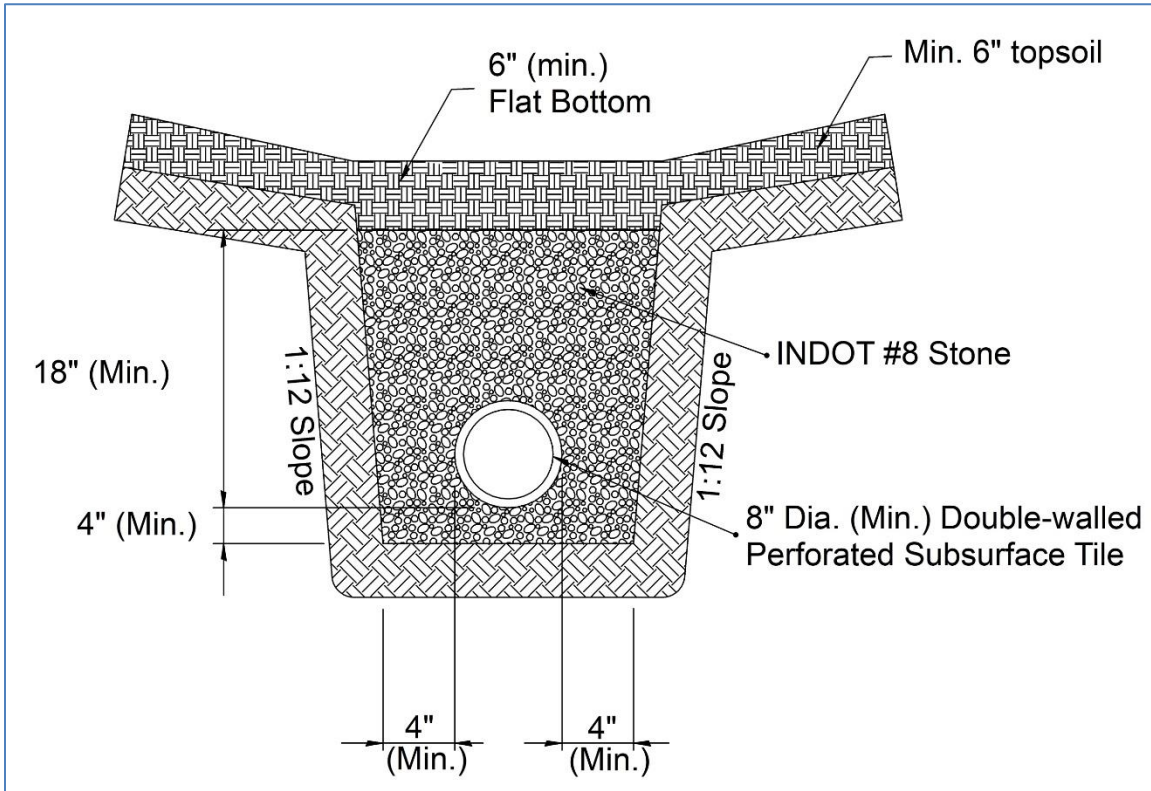

FIGURE 4-3
Bedding and Backfill Standards for Sub-drains under Swales





Chapter Five

OPEN CHANNEL DESIGN STANDARDS AND SPECIFICATIONS

All channels, whether private or public, and whether constructed on private or public land, shall conform to the design standards and other design requirements contained herein. Unless specifically referenced in a particular provision, the standards contained in this Chapter refer to open channels and not swales. Proposed open channels must be sized and designed to convey at least the 10-year frequency on-site stormwater runoff, as well as the anticipated 10-year frequency tributary off-site stormwater runoff based on the future developed condition (using Table 6-1 of the Technical Standards). An analysis of the emergency routing of stormwater runoff through the subject development must be provided to confirm that the development will not obstruct the free flow of floodwaters from the tributary off-site property in its current condition and after development. In addition, the Drainage System Overflow Design must be completed in accordance with Section M of Chapter 4 to ensure the safe routing of flood waters through the subject development with the tributary off-site property in its current condition and after development.

A. DESIGN STORM FREQUENCIES

1. All channels and swales shall accommodate, as a minimum, peak runoff from a 10-year return frequency storm calculated based on methodology described in Chapter 2.
2. Channels with a carrying capacity of more than 30 cfs at bank-full stage shall be capable of accommodating peak runoff for a 50-year return frequency storm within the drainage easement.
3. Channel facilities functioning as a major drainage system, as defined in **Appendix A**, must also meet IDNR design standards in addition to Franklin County standards. In case of discrepancy, the most restrictive requirements shall apply.
4. The 10-year storm design flow for residential rear and side lot swales shall not exceed 4 cfs. Unless designed as a Post-construction stormwater quality BMP, the maximum length of rear and side lot swales before reaching any inlet shall not exceed 400 feet.
5. Regardless of minimum design frequencies stated above, the performance of all parts of drainage system shall be checked for the 100-year flow conditions to ensure that all buildings are properly located outside the 100-year flood boundary and that flow paths are confined to designated areas with sufficient easement.
6. A minimum of 25 feet from top of the bank on each side of a new channel shall be designated on the recorded plat as a Drainage Easement. No landscaping is allowed within any Drainage Easement, except for a minimum 25-foot width of filter strip or suitable grass that shall be installed along the top of bank.

B. DETERMINATION OF CHANNEL WATERWAY AREA USING MANNING'S EQUATION

The waterway area for channels shall be determined using Manning's Equation, where:

$$A = Q/V$$

A = Waterway area of channel in square feet

Q = Discharge in cubic feet per second (cfs)

V = Steady-State channel velocity, as defined by Manning's Equation (See Chapter 4)

C. BACKWATER METHOD FOR DRAINAGE SYSTEM ANALYSIS

The determination of 100-year water surface elevation along channels and swales shall be based on accepted methodology and computer programs designed for this purpose. Computer programs HEC-RAS, HEC-2, and ICPR are preferred programs for conducting such backwater analysis. The use of other computer models must be accepted in advance by Franklin County.

D. CHANNEL CROSS-SECTION AND GRADE

1. The required channel cross-section and grade are determined by the design capacity, the material in which the channel is to be constructed, and the requirements for maintenance. A minimum depth may be required to provide adequate outlets for subsurface drains, tributary ditches, or streams. The channel grade shall be such that the velocity in the channel is high enough to prevent siltation but low enough to prevent erosion. Velocities less than 2 feet per second for the design storm are not acceptable, as siltation will take place and ultimately reduce the channel cross-section area. The maximum permissible velocities in vegetated-lined channels are shown in **Table 5-1**. In addition to existing runoff, the channel design should incorporate increased runoff due to the proposed development.
2. Where depth of design flow is slightly below critical depth, channels shall have freeboard adequate to cope with the effect of hydraulic jumps.
3. Along the streets and roads, the bottom of the ditch should be low enough to install adequately sized driveway culverts without creating "speed bumps". The driveway culvert inverts shall be designed to adequately consider upstream and downstream culvert elevations. Use of open channels and swales within the road right of way is only allowed in special circumstances when no other viable option exists. The applicant must consult with the *Franklin County* Engineer prior to design.
4. Flow of a channel into a closed system is prohibited, unless runoff rate and head loss computations demonstrate the closed conduit to be capable of carrying the 100-year channel flow for developed conditions, either entirely or in combination with a defined overflow channel, with no reduction of velocity.

TABLE 5-1

| Maximum Permissible Velocities in Vegetal-Lined Channels (1) | | | |
|--|--|---|---|
| <i>Cover</i> | <i>Channel Slope Range (Percent) (3)</i> | <i>Permissible Velocity (2)</i> | |
| | | <i>Erosion Resistant Soils (ft. per sec.) (4)</i> | <i>Easily Eroded Soils (ft. per sec.) (4)</i> |
| Bermuda Grass | 0-5 5-10 Over 10 | 8 7 6 | 6 5 4 |
| Bahia Buffalo Grass Kentucky Bluegrass Smooth Brome Blue Grama | 0-5 5-10 Over 10 | 7 6 5 | 5 4 3 |
| Grass Mixture Reed Canary Grass | (3) 0-5 5-10 | 5 4 | 4 3 |
| Lespedeza Sericea Weeping Lovegrass Yellow Bluestem Redtop Alfalfa Red Fescue | (4) 0-5 5-10 | 3.4 | 2.5 |
| Common Lespedeza (5) Sudangrass (5) | (6) 0-5 | 3.5 | 2.5 |

- (1) From Soil Conservation Service, SCS-TP-61, "Handbook of Channel Design for Soil and Water Conservation".
- (2) Use velocities exceeding 5 feet per second only where good channel ground covers and proper maintenance can be obtained.
- (3) Do not use on slopes steeper than 10 percent except for vegetated side slopes in combination with a stone, concrete, or highly resistant vegetative center section.
- (4) Do not use on slopes steeper than 5 percent except for vegetated side slopes in combination with a stone, concrete, or highly resistant vegetative center section.
- (5) Annuals - use on mild slopes or as temporary protection until permanent covers are established.
- (6) Use on slopes steeper than 5 percent is not recommended.

E. SIDE SLOPES

1. Earthen channel side slopes shall be no steeper than 3 horizontal to 1 vertical (3:1). Flatter slopes may be required to prevent erosion and for ease of maintenance.
2. Where channels will be lined with riprap, concrete, or other acceptable lining method, side slopes shall be no steeper than 2 horizontal to 1 vertical (2:1) with adequate provisions made for weep holes.
3. Side slopes steeper than 2 horizontal to 1 vertical (2:1) may be used for lined channels provided that the side lining is designed and constructed as a structural retaining wall with provisions for live and dead load surcharge.

4. When the design discharge produces a depth of greater than three (3) feet in the channel, appropriate safety precautions shall be added to the design based on reasonably anticipated safety needs at the site.

F. CHANNEL STABILITY

1. Characteristics of a stable channel are:
 - a. It neither promotes sedimentation nor degrades the channel bottom and sides.
 - b. The channel banks do not erode to the extent that the channel cross-section is changed appreciably.
 - c. Excessive sediment bars do not develop.
 - d. Excessive erosion does not occur around culverts, bridges, outfalls or elsewhere.
 - e. Gullies do not form or enlarge due to the entry of uncontrolled flow to the channel.
2. Channel stability shall be determined for an aged condition and the velocity shall be based on the design flow or the bankfull flow, whichever is greater, using an "n" value for various channel linings as shown in **Tables 4-1 and 5-1**. In no case is it necessary to check channel stability for discharges greater than that from a 100-year frequency storm.
3. Channel stability shall be checked for conditions representing the period immediately after construction. For this stability analysis, the velocity shall be calculated for the expected flow from a 10-year frequency storm on the watershed, or the bankfull flow, whichever is smaller, and the "n" value for the newly constructed channels in fine-grained soils and sands may be determined in accordance with the "National Engineering Handbook 5, Supplement B, Soil Conservation Service" and shall not exceed 0.025. The allowable velocity in the newly constructed channel may be increased by a maximum of 20 percent to reflect the effects of vegetation to be established under the following conditions:
 - a. The soil and site in which the channel is to be constructed are suitable for rapid establishment and support of erosion controlling vegetation.
 - b. Species of erosion controlling vegetation adapted to the area, and proven methods of establishment are shown.
 - c. The channel design includes detailed plans for establishment of vegetation on the channel side slopes.

G. DRAINAGE OF SWALES

All swales shall meet the following requirements and the specifications of Franklin County or designee:

1. Minimum swale flow line slopes are 1%. Swales with longitudinal slopes that are flatter than 1% shall consist of 6-inch thick rebar-reinforced concrete. The side slopes of swales shall not be steeper than a 4 (horizontal) to 1 (vertical) slope.
2. Maximum swale flow line slopes are 7%.
3. Minimum swale top width shall be 6 feet.

4. All flow shall be confined to the specific easements associated with each rear and side lot swale that are part of the minor drainage system.
5. Unless designed to act as a stormwater quality BMP or lined with concrete, vegetated swales shall have a double-walled 8-inch sub-surface drain with a minimum cover of 18 inches to dry the swales. Typical detail of a swale with sub-surface drain is shown on Figure 4-3. Tile lines may be outletted through a drop structure at the ends of the swale or through a standard tile outlet. Before reaching an open channel, the perforated drain shall be connected to 10 feet of SDR # 40. Also, cleanout risers are to be installed at the high point as well as end of run.
6. A minimum of 20 feet along the swale (10 feet from each side of the centerline) must be designated on the recorded plat as Drainage Easement.
7. Further guidance regarding this subject may be found in the latest edition of the Indiana Drainage Handbook.

H. APPURTENANT STRUCTURES

The design of channels will include provisions for operation and maintenance and the proper functioning of all channels, laterals, travelways, and structures associated with the project. Recessed inlets and structures needed for entry of surface and subsurface flow into channels without significant erosion or degradation shall be included in the design of channel improvements. The design will also provide for necessary floodgates, water level control devices, and any other appurtenance structure affecting the functioning of the channels and the attainment of the purpose for which they are built.

The effects of channel improvements on existing culverts, bridges, buried cables, pipelines, and inlet structures for surface and subsurface drainage on the channel being improved and laterals thereto shall be evaluated to determine the need for modification or replacement. Culverts and bridges which are modified or added as part of channel improvement projects shall meet reasonable standards for the type of structure, and shall have a minimum capacity equal to the design discharge or governmental agency design requirements, whichever is greater.

I. DISPOSAL OF SPOIL

Spoil material resulting from clearing, grubbing, and channel excavation shall be disposed of in a manner that will:

1. Minimize overbank wash.
2. Provide for the free flow of water between the channel and floodplain boundary unless the valley routing and water surface profiles are based on continuous dikes being installed.
3. Not hinder the development of travelways for maintenance.
4. Leave the right-of-way in the best condition feasible, consistent with the project purposes, for productive use by the owner.

J. MATERIALS

Materials acceptable for use as channel lining are:

1. Grass
2. Revetment Riprap
3. Concrete
4. Hand Laid Riprap
5. Precast Cement Concrete Riprap
6. Gabions
7. Straw, Coconut Mattings, or other accepted material (only until grass is established)

Other lining materials must be accepted in writing by Franklin County. Materials shall comply with the latest edition of the INDOT, "Standard Specifications".

K. DRAINAGE SYSTEM OVERFLOW DESIGN

See Chapter 4, Section M.



Chapter Six

STORMWATER DETENTION DESIGN STANDARDS FOR PEAK FLOW CONTROL

Basins shall be constructed to retain and/or temporarily detain the stormwater runoff that exceeds the maximum peak release rate authorized by the Ordinance and these technical standards. The required volume of storage provided in these basins, together with such storage as may be authorized in other on-site facilities, shall be sufficient to control excess runoff from the 10-year or 100-year storm as explained below in Section “B.”. Also, basins shall be constructed to provide adequate capacity to allow for sediment accumulation resulting from development and to permit the pond to function for reasonable periods between cleanings.

A. SUGGESTED CALCULATION SEQUENCES FOR DESIGNING A DETENTION POND FOR PEAK FLOW CONTROL

Peak Flow Control Only

1. Determine the main outlet’s control elevation.
2. Route the on-site 10-year and 100-year inflow hydrographs through the pond (by temporarily ignoring off-site flows) and size the main outlet to limit peak outflows to the allowable release rates. If an orifice will need to be used to limit the outflow, use the actual orifice size needed to meet the release rate requirements, unless the calculated diameter is less than 6 inches, in which case the minimum 6-inch orifice diameter shall be used. The resulting maximum water surface elevation is the top of peak flow control storage for on-site flows. If no off-site flows are routed through the detention facility, then this will be the pond’s 100-year elevation and the emergency spillway invert elevation is also set at this elevation.
3. Off-site flows that are bypassed (no detention) through the site detention pond (rather than bypassed around the pond), should be routed through a separate outlet (such as a drop inlet structure) with its control elevation set at the on-site 100-year pond elevation determined in Step 2. The 100-year pond elevation is determined by routing the on-site and off-site 100-year inflow hydrographs through the pond. Ideally, a separate emergency spillway should be provided with an invert elevation set at the combined (on-site and off-site) 100-year ponding elevation. A less desirable option would be to route the off-site flows through the emergency spillway with the invert elevation set at the on-site 100-year ponding elevation as determined in Step 2. However, since this would result in water flowing over the emergency spillway more frequently, this option may require additional erosion control measures based on the estimated frequency of use. Additional discussion on managing off-site runoff is contained in Section C.3 of this chapter.

B. ACCEPTABLE DETENTION FACILITIES

The increased stormwater runoff resulting from a proposed development should be retained (if possible) and detained on-site (if retention is not feasible due to limited infiltration capacity) by the

provisions of appropriate above- or below-ground wet bottom or dry bottom detention facilities, parking lots, or other acceptable techniques. Measures that retard the rate of overland flow and the velocity in runoff channels shall also be used to partially control runoff rates.

C. ALLOWABLE RELEASE RATES

1. General Release Rates

Control devices shall limit the discharge to a rate such that the post-developed release rate from the site is no greater than 0.1 cfs per acre of development for 0 - 10 year return interval storms and 0.3 cfs per acre of developed area for 11 - 100 year return interval storms. The above fixed general release rates may be set at a lower value by Franklin County for geographical areas determined as Impact Drainage Area or for certain watersheds if more detailed data becomes available as a result of comprehensive watershed studies conducted and/or formally approved and adopted by Franklin County. The applicant shall confirm the applicable release rates with Franklin County or designee prior to initiating the design calculations to determine whether a basin-specific release rate has been established for the watershed of their interest or whether the site is located within a designated or an Impact Drainage Area.

For sites where the pre-developed area has more than one (1) outlet, the release rate should be computed based on pre-developed discharge to each outlet point. The computed release rate for each outlet point shall not be exceeded at the respective outlet point even if the post developed conditions would involve a different arrangement of outlet points.

2. Site-Specific Release Rates for Sites with Depressional Storage

For sites where depressional storage exists, the general release rates provided above may have to be further reduced. If depressional storage exists at the site, site-specific release rates must be calculated according to methodology described in Chapter 2, accounting for the depressional storage by modeling it as a pond whose outlet is a weir at an elevation that stormwater can currently overflow the depressional storage area. Post developed release rate for sites with depressional storage shall be the 2-year pre-developed peak runoff rate for the post-developed 10-year storm and 10-year pre-developed peak runoff rate for the post-developed 100-year storm. In no case shall the calculated site-specific release rates be larger than general release rates provided above.

Note that by definition, the depressional storage does not have a direct gravity outlet but if in agricultural production, it is more than likely drained by a tile and should be modeled as “empty” at the beginning of a storm. The function of any existing depressional storage should be modeled using an event hydrograph model to determine the volume of storage that exists and its effect on the existing site release rate. To prepare such a model, certain information must be obtained, including delineating the tributary drainage area, the stage-storage relationship and discharge-rating curve, and identifying the capacity and elevation of the outlet(s).

The tributary area should be delineated on the best available topographic data. After determining the tributary area, a hydrologic analysis of the watershed should be performed, including, but not limited to, calculation of the appropriate composite runoff curve number and time of concentration. Stage-storage data for the depressional area should be obtained from the site topography. The outlet should be clearly marked, and any calculations performed to create a stage-discharge rating curve must be included with the stormwater submittal.

Also note that for determining the post-developed peak runoff rates, the depressional storage must be assumed to be filled unless Franklin County can be assured, through dedicated easement, that the noted storage will be preserved in perpetuity.

3. Management of Off-site Runoff

Runoff from all upstream tributary areas (off-site land areas) may be bypassed around the retention/detention facility without attenuation. Such runoff may also be routed through the detention/retention facility, provided that a separate outlet system or channel is incorporated for the safe passage of such flows, i.e., not through the primary outlet of a detention facility.

Note that the efficiency of the retention/detention facility in controlling the on-site runoff may be severely affected if the off-site area is considerably larger than the on-site area. As a general guidance, on-line detention may not be effective in controlling on-site runoff where the ratio of off-site area to on-site area is larger than 5:1. Additional detention (above and beyond that required for on-site area) may be required by Franklin County when the ratio of off-site area to on-site area is larger than 5:1.

4. Downstream Restrictions

In the event the downstream receiving channel or storm sewer system is inadequate to accommodate the post-developed release rate provided above, then the allowable release rate shall be reduced to that rate permitted by the capacity of the receiving downstream channel or storm sewer system. Additional detention, as determined by Franklin County, shall be required to store that portion of the runoff exceeding the capacity of the receiving sewers or waterways. When such downstream restrictions are suspected, Franklin County may require additional analysis to determine the receiving system's limiting downstream capacity.

If the proposed development makes up only a portion of the undeveloped watershed upstream of the limiting restriction, the allowable release rate for the development shall be in direct proportion to the ratio of its drainage area to the drainage area of the entire watershed upstream of the restriction.

As an alternative to reduction of release rates, Franklin County may require the applicant to pursue alleviating downstream restrictions. The applicant would be responsible for obtaining all permits and consents required and for incurring all expenses involved in such undertaking.

5. Documentation of Results

The results of the allowable release rate determinations (if retaining the entire required peak flow rate volume is not feasible) as well as the modeling simulation results must be summarized in a table that shall be included in the Stormwater Drainage Technical Report and on the Drainage Plan. The table must include, for each eventual site outlet, the pre-developed acreage tributary to each eventual site outlet, the unit discharge allowable release rate used, the resulting allowable release rate in cfs for the post-developed 10-year and 100-year events, pre-developed 2-year flow rates in cfs as well as pre- and post-developed flow rates for 2-, 10-, and 100-year events. The worksheet provided as Table 6-1 should be filled for each final site outlet.

TABLE 6-1

| SITE OUTLET # | ITEM | PRE-DEVELOPMENT | | | | | POST-DEVELOPMENT | | | | |
|---------------------|--|-----------------|----------------------------------|-------|------------|-------------|------------------|----------------------------------|-------|------------|-------------|
| | | D.A. (ac) | Depress. Storage? (yes/no) | 2-Yr. | 10- Yr. | 100- Yr. | D.A. (ac) | Depress. Storage? (yes/no) | 2-Yr. | 10- Yr. | 100- Yr. |
| 1 | Default Unit Discharge Allowable Release Rate (cfs/acre) | | | | | | | | | 0.1 | 0.3 |
| | Basin-Specific Unit Discharge Allowable Release Rate, if any (cfs/acre) | | | | | | | | | | |
| | Unit Discharge Allowable Release Rate Based on D/S Restrictions, if any (cfs/acre) | | | | | | | | | | |
| | Adopted Unit Discharge Allowable Release Rate (cfs/acre) | | | | | | | | | | |
| | Contributing Area of Development Site (ac) and Allowable Release Rate (cfs) | | | | | | | | | | |
| | Total Contributing DA (ac) and Modeling Results (cfs) | | | | | | | no | | | |

D. GENERAL DETENTION BASIN DESIGN REQUIREMENTS

1. The retention/detention facility shall be designed in such a manner that a minimum of 90% of the maximum volume of water stored and subsequently released at the design release rate (if not retaining the entire peak flow rate volume) shall not result in a storage duration in excess of 48 hours from the start of the storm unless additional storms occur within the period. In other words, the design shall ensure that a minimum 90% of the original retention/detention capacity is restored within 48 hours from the start of the design 100-year storm.
2. The 100-year elevation of stormwater retention/detention facilities shall be separated by not less than 25 feet from any building or structure to be occupied. The Lowest Adjacent Grade (including walkout basement floor elevation) for all residential, commercial, or industrial buildings shall be set a minimum of 2 feet above the 100-year pond elevation or 2 feet above the emergency overflow weir elevation, whichever is higher. In addition to the Lowest Adjacent Grade requirements, any basement floor must be at least a foot above the normal water level of any wet-bottom pond or the local groundwater table, whichever is higher, to avoid the overuse of sump pumps and frequent flooding of the basement.
3. No detention facility or other water storage area, permanent or temporary, shall be constructed under or within twenty (20) feet of any pole or high voltage electric line. Likewise, poles or high voltage electric lines shall not be placed within twenty (20) feet of any detention facility or other water storage area.
4. Detention facilities shall be separated from parking lots and roadways by an appropriately-selected and designed method of safety barrier, such as guard rails, bollards, or other physical barriers capable of deterring the passage of a vehicle into the pond.
5. Slopes no steeper than 3 horizontal to 1 vertical (3:1) for safety, erosion control, stability, and ease of maintenance shall be permitted.
6. Safety screens having a maximum opening of six (6) inches shall be provided for any pipe or opening end sections 12-inch in diameter or larger. Storm drain pipes outletting into the pond shall not be submerged.
7. Use of fences around all retention/detention ponds is encouraged to assure safety. Unless specifically required by Franklin County, the decision to use fencing around retention/detention ponds are left to the owner or the developer. Recommendations contained within this document do not relieve the applicant and owner/developer from the responsibility of taking all necessary steps to ensure public safety with regards to such facilities.
8. Outlet control structures shall be designed to operate as simply as possible and shall require little or no maintenance and/or attention for proper operation. For maintenance purposes, the outlet from the pond (if any) shall be a minimum of 0.5 foot above the normal water level of the receiving water body. They shall limit discharges into existing or planned downstream channels or conduits so as not to exceed the predetermined maximum authorized peak flow rate. If an outlet control structure includes an orifice to restrict the flow rate, such orifice shall be no less than 6 inches in diameter.
9. Emergency overflow facilities such as a weir or spillway shall be provided for the release of exceptional storm runoff or in emergency conditions should the normal discharge devices

become totally or partially inoperative. The overflow facility shall be of such design that its operation is automatic and does not require manual attention.

Emergency overflow facilities shall be designed to convey, without overtopping the detention facility banks, one and one-quarter (1.25) times the peak inflow discharge resulting from the 100-year design storm event runoff from the entire contributing watershed draining to the detention/retention facility, assuming post-development condition on-site and existing condition off-site. The length of the weir is to be determined using the weir equation, with the overflow weir control elevation at the Pond's 100-year elevation (pond is assumed full to the overflow weir control elevation), discharge equal to 1.25 times the peak 100-year inflow, and the maximum head being the difference between the weir control elevation and the top of the bank.

The emergency overflow routing from the emergency overflow facility to an adequate receiving system must be positive (by gravity) and shown on the construction plans. It must be sized to accommodate the design flow of the pond's emergency overflow weir. A minimum of thirty (30) feet width along the centerline of this emergency overflow route or the flow width required to accommodate the emergency spillway design flow, whichever is greater, shall be designated as permanent drainage easement. This emergency overflow path/easement area shall be shown on the plans as hatched area or another distinctive symbol. No fences or landscaping can be constructed within the easement areas. The Lowest Adjacent Grade of all residential, commercial, or industrial buildings along this emergency overflow route shall be set a minimum of 2 feet above the flood elevation along the route, calculated based on the pond's emergency overflow weir design discharge.

10. Grass or other suitable vegetative cover shall be provided along the banks of the retention/detention storage basin. Vegetative cover around detention facilities should be maintained as appropriate.
11. Debris and trash removal and other necessary maintenance shall be performed on a regular basis to assure continued operation in conformance to design.
12. No residential lots or any part thereof shall be used for any part of a detention basin assumed full to the 100-year water surface elevation or the emergency overflow weir elevation, whichever is higher. Detention basins, assumed full to the 100-year water surface elevation or the emergency overflow weir elevation, whichever is higher, shall be placed within a common area either platted or legally described and recorded as a perpetual stormwater easement.
13. A minimum of twenty (20) feet horizontally from the top of bank of the facility, or the 100-year pool if no defined top of bank is present, shall be dedicated as permanent stormwater easement if the above-noted boundary of the common area does not extend that far. Within this easement area, no trees shall be planted within 50 feet of any pipe outlet entering the pond or the outlet for the pond.

In addition, an exclusive easement to assure access to the pond from an adjacent public street/road right of way shall be required. No above-ground utilities or other obstruction that may hinder access shall be allowed within this exclusive access easement. Additional access easements may be required for larger ponds,

E. ADDITIONAL REQUIREMENTS FOR WET-BOTTOM FACILITY DESIGN

Where part of a detention facility will contain a permanent pool of water, all the items required for detention storage shall apply. Also, a controlled positive outlet will be required to maintain the design water level in the wet bottom facility and provide required detention storage above the design water level. However, the following additional conditions shall apply:

1. Facilities designed with permanent pools or containing permanent lakes shall have a water area of at least one-half (0.5) acre with a minimum depth of eight (8) feet over the majority of pond area. If fish are to be used to keep the pond clean, a minimum depth of approximately ten (10) feet shall be maintained over at least 25 percent of the pond area. The remaining pond area shall have no extensive shallow areas, except as required to install the safety ramp, safety ledge, and BMPs as required below. Construction trash or debris shall not be placed within the permanent pool.
2. All wet detention/retention ponds must be constructed in as natural a shape (footprint) as possible and have a vegetated safety ledge (approximately 6 inches below normal pool) and/or have native vegetation planted on the pond banks to create a riparian buffer (minimum 10 feet wide). Native vegetation can be installed as container grown plants or as seed at the time of construction. If native vegetation is planted on the pond banks, signage must be provided indicating that it is a natural "Do Not Mow" area. The vegetation should be planted in a manner so as not to hide or disguise the ponds edge. Maintenance of the vegetated barrier shall be the responsibility of the owner or the homeowners' association. All pond slopes shall be 3:1 (horizontal to vertical) or flatter.
3. For wet-bottom facilities without a security fence, a maintenance ledge ten (10) feet in width is required and shall be installed approximately 12 inches above the permanent water level and a safety ledge ten (10) feet in width is required and shall be installed approximately 6 inches below the permanent water level. If a non-vegetated safety ledge is installed, the depth of the safety ledge shall be approximately 18 inches below normal pool. The slope between the two ledges shall be stable and protected from erosion with hard armoring or bioengineered techniques.

For wet-bottom facilities with a security fence, a maintenance ledge six (6) feet in width is required and shall be installed approximately 12 inches above the permanent water level and a safety ledge six (6) feet in width is required and shall be installed approximately 6 inches below the permanent water level. If a non-vegetated safety ledge is installed, the depth of the safety ledge shall be approximately 18 inches below normal pool. The slope between the two ledges shall be stable and protected from erosion with hard armoring or bioengineered techniques.

The maintenance ledge may be waived if pond side slopes above normal water are 6:1 or flatter.

4. Prior to final acceptance of construction and release of bonds, danger signs warning of deep water, possible flood conditions during storm periods, or other dangers, shall be installed at an interval of 400 feet around the perimeter of wet-bottom facilities without a vegetated safety ledge, riparian buffer, or a security fence. Maintenance of the warning signs shall be the responsibility of the owner or the homeowners' association.
5. If a retaining wall is used below the normal pool of wet detention pond, the wall shall have either steps or a ladder incorporated into the construction at the center of the wall span.
6. A safety ramp exit from the lake shall be required in all cases and shall have a minimum width of twenty (20) feet and exit slope of 6 horizontal to 1 vertical (6:1). The safety ramp shall be

constructed of suitable material to prevent structural instability due to vehicles or wave action. Adequate access to the safety ramp shall be provided by locating it adjacent to public right-of-way or by providing a clear route recorded within an access easement or a common area.

7. In addition to provisions specified in Section C.4 of this Chapter (if applicable), parks, playgrounds, and athletic fields shall be separated from all stormwater detention facilities by no less than 100 feet, measured from the 100-year pool of the pond. Trails and sidewalks shall be separated from all stormwater detention facilities by no less than 25 feet, measured from the 100-year pool of the pond.
8. Periodic maintenance is required in lakes to control weed and larval growth. The facility shall also be designed to provide for the easy removal of sediment that will accumulate during periods of reservoir operation. A means of maintaining the designed water level of the lake during prolonged periods of dry weather may also be required.
9. For maintenance purposes, the outlet of storm sewers entering the pond shall be a minimum of 0.5 foot above the normal pool level.
10. Methods to prevent pond stagnation, including but not limited to surface or sub-surface aeration or destratification facilities that can, at the minimum, achieve one complete pond volume turnover per day should be considered. Figure below shows a typical diffuser aeration system that consists of a quiet air compressor at the shore, aeration tubing, and one or more sets of diffuser head(s).

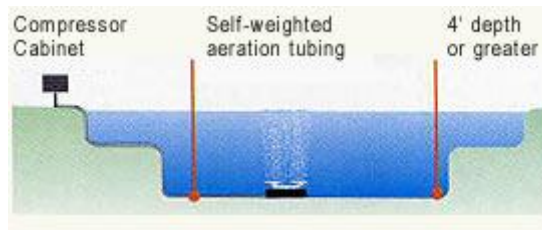

Irregularly shaped ponds should be treated as two or three separate ponds. Likewise, larger ponds will also need multiple aeration units.

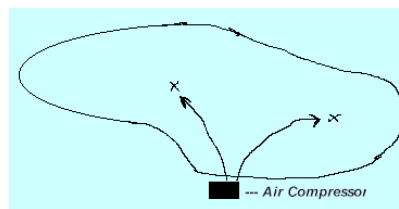

Design calculations to substantiate the effectiveness of proposed aeration facilities shall be submitted with final engineering plans. Design calculations should, at a minimum, indicate that the device and/or series of devices are providing a minimum volume turnover of once per 24 hours over the majority of the pond volume (i.e. pump radius of influence calculations, etc.). Agreements for the perpetual operation and maintenance of aeration facilities by the property owner or the HOA shall be prepared.

If the detention pond is also proposed to be used as a post-construction stormwater BMP, alternative means of aeration (such as diffuser aeration systems) shall be used that would not result in re-suspension of sediment particles and would not prevent the efficient settling of sediment particles.

11. If the facility is being located near an airport, a minimum horizontal separation distance between the airport property and the pond will need to be provided in accordance to Federal Aviation Administration (FAA) advisory Circular 150/5200-33, titled "Hazardous Wildlife Attractions On or Near Airports" and dated 8/28/2007, or the latest update of the same.

F. ADDITIONAL REQUIREMENTS FOR DRY-BOTTOM FACILITY DESIGN

In addition to general design requirements, retention/detention facilities that will not contain a permanent pool of water shall comply with the following requirements:

1. Provisions shall be incorporated into facilities for complete interior drainage of dry bottom facilities, including the provisions of natural grades to outlet structures (if any), longitudinal and transverse grades to perimeter drainage facility. Unless designed as a retention facility, a 6-inch underdrain with a minimum of 1.5 feet of cover shall be provided within all dry-bottom ponds.
2. For residential developments, unless the facility is fully fenced in and gated, the maximum planned depth of stormwater stored shall not exceed four (4) feet.
3. In excavated retention/detention facilities, a minimum side slope of 3:1 shall be provided for stability. In the case of valley storage, natural slopes may be considered to be stable.

G. DETENTION FACILITIES IN FLOODPLAINS

No detention facilities are allowed within FEMA regulatory floodplains.

H. JOINT DEVELOPMENT OF CONTROL SYSTEMS

Stormwater control systems may be planned and constructed jointly by two or more developers as long as compliance with this Ordinance is maintained.

I. DIFFUSED OUTLETS

When the allowable runoff is released in an area that is susceptible to flooding or erosion, the developer may be required to construct appropriate storm drains through such area to avert increased flood hazard caused by the concentration of allowable runoff at one point instead of the natural overland distribution. The requirement of diffused outlet drains shall be at the discretion of Franklin County.

J. IDNR REQUIREMENTS

Any construction in the floodway of a stream with a drainage area of one square mile or more must satisfy IDNR permit requirements.

K. ALLOWANCE FOR SEDIMENTATION

Retention/detention basins shall be designed with an additional ten (10) percent of available capacity to allow for sediment accumulation resulting from development and to permit the pond to function for reasonable periods between cleanings. Basins should be designed to collect sediment and debris in specific locations, such as a forebay, so that removal costs are kept to a minimum. For wet-bottom ponds, the sediment allowance may be provided below the permanent pool elevation. No construction trash or debris shall be allowed to be placed within the permanent pool. If the pond is used as a sediment control measure during active construction, the performance sureties will not be released until sediment has been cleaned out of the pond and elevations and grades have been reestablished as noted in the accepted plans.

L. MAINTENANCE

The routine maintenance of stormwater detention facilities (i.e. trash pickup, aeration, weed control, sediment removal, etc.) is the responsibility of the Homeowners' Association.



Chapter Seven

LOT/BUILDING GRADING AND DRAINAGE STANDARDS

A. GRADING AND BUILDING PAD ELEVATIONS

Minimum Federal and State Requirements

For all structures located in the Special Flood Hazards Area (SFHA) as shown on the FEMA maps and/or that mapped by the IDNR based on Best Available Data, the Lowest Floor elevation, including basement, shall be at or above the flood protection grade (FPG) and therefore have a minimum of 2 feet of freeboard above the 100-year flood elevation. Additional requirements for buildings within SFHA are contained in the *Franklin County Floodplain Management Ordinance*.

Additional Local Requirements

FPG for all buildings located within or adjacent to SFHA shall be shown on the secondary plat.

For all structures located outside SFHA or an IDNR designated floodplains that are subject to flooding from a detention/retention pond, the lowest adjacent grade (LAG) of all residential, commercial, or industrial buildings shall have a minimum of 2 feet of freeboard above the 100-year flood elevation or the emergency overflow weir elevation, whichever is higher.

For all structures located outside SFHA or an IDNR designated floodplains that are subject to flooding from a stream or an open ditch or other waterway (an area along a stream with no floodplain designation or an area adjacent to a designated floodplain with ground elevation below 100-year flood elevation plus 2 feet), the LAG of all residential, commercial, or industrial buildings shall have a minimum of 2 feet of freeboard above the 100-year flood elevation of that open ditch or waterway.

For all structures fronting a flooding source other than a swale or an emergency flood route, the floor of any basements or crawl spaces (if provided) shall be a minimum of 1 foot above the normal pool level (if pond) or the 2-year flood level (if a stream or an open ditch). In addition, special considerations, based on detailed geotechnical analysis, should be made prior to considering placement of any basement below the 100-year flood elevation of an adjacent flooding source or pond.

For all structures adjacent to an emergency flood route (also referred to as overflow path/ponding areas), the minimum adjacent grade of the portion of the structure (the ground elevation next to the building after construction is completed that sits adjacent to the emergency flood route or may be subject to flooding by the emergency flood route) shall be a minimum of 1 foot above the estimated 100-year elevation of the emergency flood route assuming that all stormwater inlets and pipes are fully clogged, with no discharge into the storm sewer system. The building adjacent grade requirements (including default elevations above the overflow route bottom) for buildings adjacent to overflow path/ponding areas are further discussed in Chapters 4 of this Manual.

For all structures adjacent to a road, the building's lowest entry elevation that is adjacent to and facing a road shall be a minimum of 2 feet above the road elevation (elevation of the gutter at the center of the lot) so that the road drainage is not directed against the building.

There shall be a positive slope drainage away from the building with maximum yard slopes that are 3:1 where soil has been disturbed during construction processes. Finished floor elevation or the lowest building entry elevation must be no less than 6 inches above finished grade around the building.

In addition to any other provisions in the Ordinance or these Standards, no buildings shall be placed within 25 feet from the top of the bank of any existing or proposed stream, drain, or watercourse, regardless of the contributing drainage area or the bank height.

B. LOT DRAINAGE

All lots shall be laid out so as to provide drainage away from all buildings, and individual lot drainage shall be coordinated with the general stormwater drainage pattern for the subdivision. Drainage shall be designed so as to avoid the concentration of stormwater runoff from a lot onto adjacent lots. Each lot owner shall maintain the lot grade, as it relates to stormwater drainage, in compliance with the approved construction plans.

No part of the lot area of any lot may contain land that is utilized as retention or detention facility or drainage pond, contains a watercourse, or is within a floodway. Where a watercourse separates the buildable area of the lot from the street by which it has access, provisions shall be made for the installation of a culvert or other appropriate structure, as approved by Franklin County or designee. If a subdivision contains an existing or to be developed waterbody, watercourse, or portion thereof, appropriate documentary assurances acceptable to Franklin County shall be provided for the maintenance of such waterbody or watercourse.

It shall be the property owners' responsibility to maintain the natural features on their lots and to take preventive measures against any and all erosion and/or deterioration of natural or manmade features on their lots.

C. ACCEPTABLE OUTLET AND ADJOINING PROPERTY IMPACTS POLICIES

Design and construction of the stormwater facility shall provide for the discharge of the stormwater runoff from off-site land areas as well as the stormwater from the area being developed (on-site land areas) to an acceptable outlet(s) (as determined by Franklin County) having capacity to receive upstream (off-site) and on-site drainage. A Roadside Ditch is generally not considered an adequate outlet. The flow path from the development outfall(s) to a regulated drain, a *Franklin County* storm drain, or natural watercourse (as determined or approved by Franklin County) shall be provided on an exhibit that includes topographic information. Any existing field tile encountered during the construction shall also be incorporated into the proposed stormwater drainage system or tied to an acceptable outlet.

If an adequate outlet is not located on site, then off-site drainage improvements may be required. Those improvements may include, but are not limited to, extending storm sewers, clearing, dredging

and/or removal of obstructions to open drains or natural water courses, and the removal or replacement of undersized culvert pipes as required by Franklin County.



Chapter Eight

RIVER CORRIDOR, BLUFFS, AND FLOODPLAIN PROTECTION STANDARDS

A. DEVELOPMENT WITHIN FLOODWAYS AND FLUVIAL EROSION HAZARD CORRIDORS

Regulatory Floodway and Fluvial Erosion Hazard (FEH) Corridor along regulated drains or any natural stream watercourse are considered Impact Drainage Areas and must be preserved to the extent possible to minimize flooding and erosion impacts within the stream system.

Basis for Establishing Floodways

The regulatory floodway along *Franklin County* streams are established as detailed in the latest edition of the *Franklin County* Floodplain Management Ordinance.

Basis for Establishing Fluvial Erosion Hazard (FEH) Corridors

The Indiana Silver Jackets Hazard Mitigation Task Force has initiated a multi-agency program to identify, study and provide mitigation planning resources for communities who would like to adopt Fluvial Erosion Hazard (FEH) avoidance strategies. The resources provided by this project enable individuals and communities to better recognize areas prone to natural stream-erosion processes and adopt strategies to avoid FEH-related risks. The FEH resources define approximate setbacks for communities to better manage river corridors. The setbacks vary based on the stream's recent migration history (actively migrating or relatively stationary).

For actively migrating and relatively stationary streams, a GIS analysis algorithm generated bankfull width values for each stream segment using regional curves that are based on drainage area within each physiographic region in Indiana. For relatively stationary streams, the analysis used these values to create buffer zones of at least one bankfull width on each side (a total corridor width of 3 times bankfull width) or 100 feet on each side of the bankfull bank, whichever is greater. For actively migrating streams, GIS generated a total corridor width of 8 times bankfull width, which was manually edited and refined to reflect the digital elevation model and stream meander evidence.

It should be noted that the FEH corridors were created at a map scale of approximately 1:10,000 to 1:15,000. The depicted areas were not meant to be accurate beyond providing an approximate boundary of potential stream migration. A data layer containing FEH Corridors along Indiana streams is currently hosted by IDNR-Division of Water on their mapping portal currently at: <https://indnr.maps.arcgis.com/apps/webappviewer/index.html?id=43e7b307a0184c7c851b5068941e2e23>. The IDNR website notes that, due to its level of detail, this data is not intended for use in project design or parcel level site analysis and that a more detailed analysis of the localized geology and fluvial mechanics is necessary for the proper evaluation of the fluvial erosion hazard.

Despite its inherent level of accuracy, the FEH corridor map created by the Indiana Silver Jackets constitutes the best available data in *Franklin County* and is the basis for regulating development within these corridors by *Franklin County*. More detailed mapping than that used as part of the

Indiana Silver Jackets erosion hazard mapping program may be provided by the applicant if it is based on detailed field assessment acceptable to Franklin County.

Special Requirements within Floodways and FEH Corridors

No disturbance (fill or excavation) associated with a new development or redevelopment is permitted within FEH corridors or regulatory floodways, unless such modifications are part of a stream-wide restoration plan or a watershed master plan. This restriction does not apply to stormwater or tile outfalls. Any streambank stabilization effort within an FEH corridor shall require prior review by Franklin County to safeguard against potential negative impacts on other properties or on the stream morphological system. Note that if a stream that is located within incorporated area of a community is designated as a County regulated drain, the proposed activities in the FEH corridor shall be under the County's jurisdiction.

B. ADDITIONAL CONSIDERATION FOR DEVELOPMENT WITHIN OR ADJACENT TO BLUFF ZONES AND STEEP SLOPES

In addition to riverine erosion hazards that exist due to lateral migration of streams as discussed in Section D (above), there are hazardous areas along many bluffs and steep slopes existing in *Franklin County*. For the purpose of these Standards, Bluff is defined as a natural topographic feature having:

- a. A slope that rises at least 25 feet and the grade of the slope averages 30 percent or greater, measured over a horizontal distance of 25 feet, from the toe of the slope to the top of the slope. Where the slope begins below the ordinary high water level, the ordinary high water level is the toe of the slope. See **Figure 11-1**; or
- b. A natural escarpment or cliff with a slope that rises at least ten feet above the ordinary high water level or toe of the slope, whichever is applicable, to the top of the slope, with a slope of 75 degrees or greater. See **Figure 11-2**.

These bluffs exist in many places and do not have to be necessarily along a permanent stream. They may be along the rivers (but sometimes outside the floodway and FEH zones) or along many headcut channels and developing ravines in *Franklin County* that may be tributary to various streams. To prevent buildings from damage due to natural slope adjustment next to bluffs, a minimum of 40 feet of landward setback shall be required from top of the bluff as illustrated in Figures 11-1 and 11-2. If a floodway or FEH is also present on the site, the most landward limit shall govern.

The definition of other terms shown in Figures 11-1 and 11-2 are as follows:

- Bluff impact zone: A bluff and land located within 20 feet of the bluff.
- Bluffline: A line delineating the top of the bluff. More than one bluffline may be encountered proceeding landward from the river.
- Toe of Bluff: A line along the bottom of a bluff, requiring field verification, such that the slope above the line exceeds 30 percent and the slope below the line is 30 percent or less, measured over a horizontal distance of 25 feet.

- Top of Bluff: A line along the top of a bluff, requiring field verification, such that the slope below the line exceeds 30 percent and the slope above the line is 30 percent or less, measured over a horizontal distance of 25 feet.

Where principal structures exist on the adjoining lots on both sides of a proposed building site, the minimum setback may be altered to conform to the average of the adjoining setbacks.

In addition to structure setback noted above, with the exception of erosion control practices sanctioned by or approved by Franklin County, no land disturbance (fill or excavation) shall be allowed within a Bluff Impact Zone.

Also note that the minimum setback required in these standards is just that: a minimum, which is based on national experience. When buildings or other infrastructure is proposed near bluffs or steep slopes, the applicant is encouraged to seek a detailed geotechnical evaluation that may result in needing to have a larger setback or have special provisions even when the slopes are gentler than that regulated in these Standards.

**Figure 11-1
Bluff and Bluff Impact Zone**

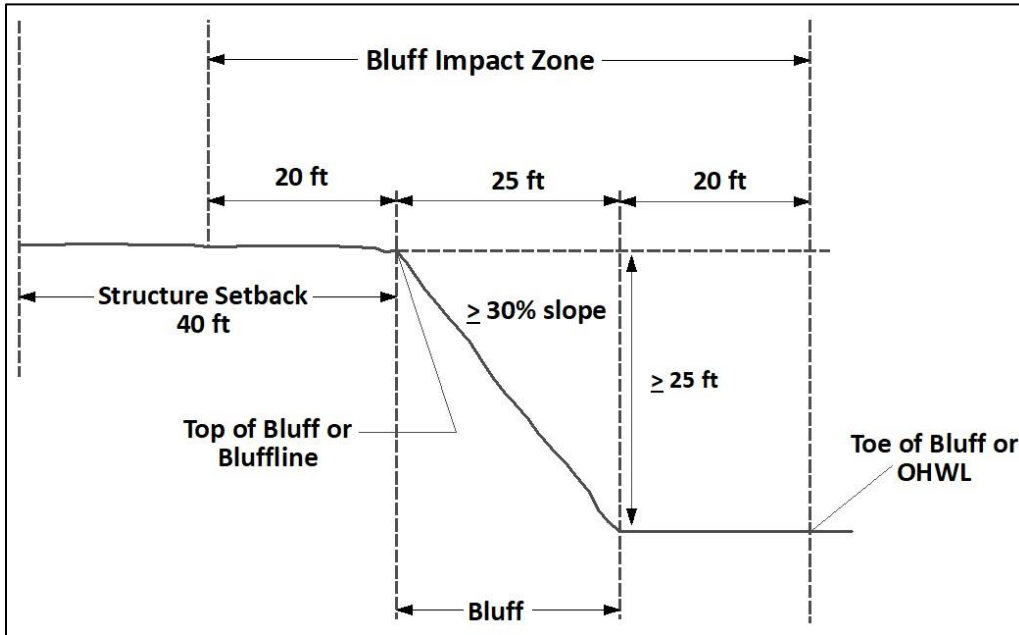

**Figure 11-2
Natural Escarpment Bluff and Bluff Impact Zone**

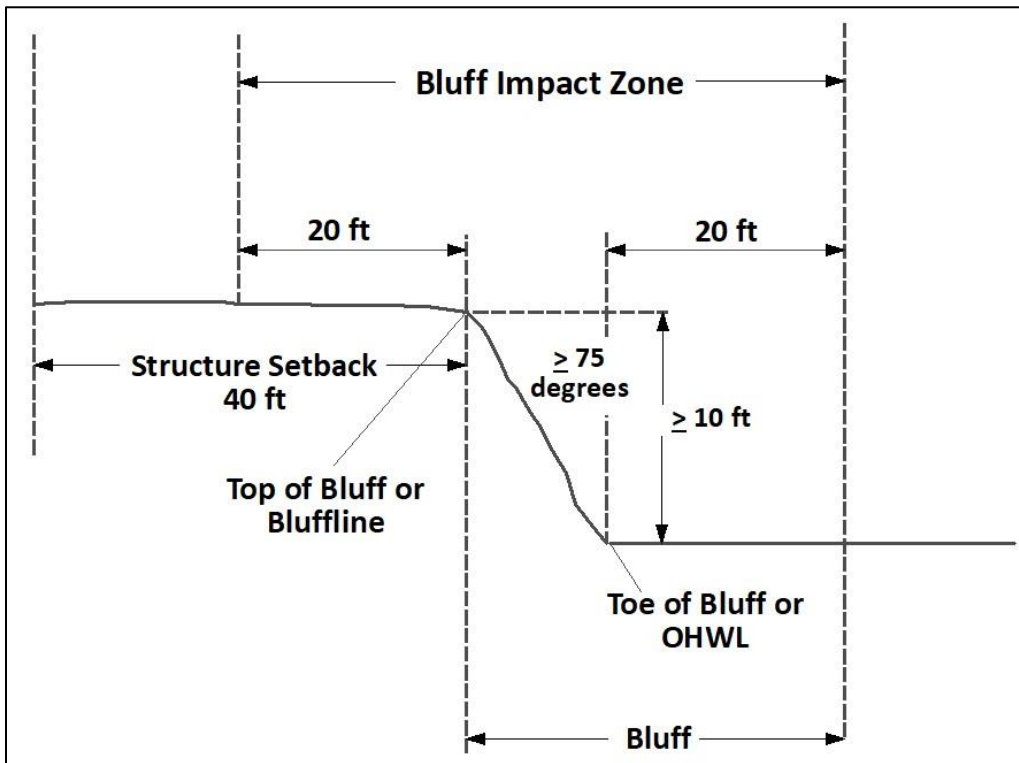

C. FLOODPLAIN AVOIDANCE / NO NET LOSS FLOODPLAIN STORAGE POLICY

Floodplains exist adjacent to all natural and man-made streams, regardless of contributing drainage area or whether they have been previously identified or mapped. Due to potential impacts of floodplain loss on peak flows in streams and on the environment, floodplains are considered Impact Drainage Areas and disturbance to these areas should be avoided. When the avoidance of floodplain disturbance is not practical, the natural functions of the floodplain should be preserved to the extent possible.

In an attempt to strike a balance between the legitimate need for economic development within the *Franklin County* jurisdictional area and the ever-increasing importance of and the need to preserve the natural functions of floodplains to the extent possible (especially given the ongoing and projected climate change impacts), compensatory excavation equivalent to the floodplain storage lost shall be required for all activities within area inundated by the 100-year flood elevation plus 2 feet along floodplain of streams located in *Franklin County* where drainage area of the stream is equal to or larger than one square mile. Franklin County may alter the compensation ratio, based on extenuating circumstances, for a specific project.

General Requirements

Note that by definition, compensatory storage is the replacement of the existing floodplain and, in rare exceptions, the floodway storage lost due to fill. Compensatory storage is required when a portion of the floodplain is filled, occupied by a structure, or when as a result of a project a change in the channel hydraulics occurs that reduces the existing available floodplain storage. Compensatory storage must:

- Be provided regardless of whether the flooding source is mapped or whether flood elevations are published or not. When flood elevations are not available for a flooding source that has a drainage area equal to or larger than one (1) square mile (640 acres), the applicant is to determine the 10-year and 100-year flood elevations at the site and get them approved by the IDNR prior to use for floodplain compensation calculations.
- Equal at least 1 times the volume of flood storage lost below the 10-year elevation and storage lost between 10-year and 100-year plus 2 feet flood elevations;
- Be operational prior to placement of fill, structures, or other materials temporarily or permanently placed in the regulatory floodplain;
- Be provided in the immediate vicinity of the flood storage lost, where practical;
- Be provided in such a way to mimic as close as possible the function provided by the lost floodplain storage. If the floodplain storage is to be lost outside the active flow conveyance path, then it must be compensated for outside the flow conveyance path (e.g., a flood conveyance shelf/2-stage ditch, while improving conveyance and erosion, is not an appropriate compensation for floodplain storage lost in the floodway fringe area).
- Be provided in addition to the site retention/detention volume; and
- Drain freely and openly to the waterway.

Compensatory storage is also required to be provided incrementally such that:

- All floodplain storage/conveyance capacity lost within the floodway shall be compensated for within the floodway;
- All floodplain storage lost within the floodway fringe shall be compensated for within the floodway fringe;
- All floodplain storage lost below the existing 10-year flood elevation shall be compensated for below the proposed 10-year flood elevation; and
- All floodplain storage lost above the existing 10-year flood elevation shall be compensated for above the proposed 10-year flood elevation.

Note that compensatory storage is required for activities in the regulatory floodplain. There is no threshold to compensatory storage; any volume of fill requires compensatory storage be provided. However, the compensatory storage requirement does not apply to specific activities in the regulatory floodplain, such as the floodproofing of an existing building, where the floodproofing measures such as berms or floodwalls are within 10 feet of the building, or crossing improvements, where artificially created storage is lost due to a reduction in head loss.

Computing Compensatory Storage

Computations must show 1 times compensation for floodplain storage volume lost for 10-year and 100-year storm plus 2 feet events. Storage lost between the existing ground and the existing 10-year flood elevation must be compensated by providing 1 time the amount lost and be placed between the existing ground elevation and the proposed 10-year floodplain elevation. Storage lost between the existing 10-year and the existing 100-year plus 2 feet elevation must be compensated by providing 1 time the amount lost and be placed between the proposed 10-year elevation and proposed 100-year plus 2 feet elevation.

When preparing a grading plan, thought should be given to how compensatory storage will be quantified. The most common methodology is the use of cross sections and the “average end area method”. The following requirements should be followed when preparing cross sections:

1. Prepare a detailed topographic survey tied to North American Vertical Datum of 1988 and the *Franklin County* Survey Control Network benchmarks.
2. Locate cross sections parallel to each other and perpendicular to a reference line, often times a property line or fence line. Cross sections used in a hydraulic model are always perpendicular to flood flows, and not always parallel to each other. Therefore, these are often not suitable for computing flood fringe compensatory storage volumes.
3. Plot cross sections at a standard engineering scale so as to allow the reviewer to verify areas. Horizontal scale should be a maximum of 1”=50’ and vertical scale should be a maximum of 1”=5’, or as approved by the County.
4. Show existing grades, proposed grades, existing and proposed 10-year flood elevations, existing and proposed 100-year flood elevations, normal water level, a reference line, and floodway limits on the cross sections on the plans.
5. Locate cross sections no more than 150 feet apart, with a minimum of three cross sections per cut/fill area, or as necessary to accurately quantify cuts and fills.
6. Locate cross sections to pick up critical features such as berms, ditches, and existing and proposed structures.

7. Each cross section should be numbered or lettered and referenced on the plans.

This information is then utilized to compute the areas of cut and fill. A sample grading plan, a typical cross section, and associated compensatory storage calculations for the 10-year flood are provided on **Figures 11-3**, **Figure 11-4**, and **Table 11-1**, respectively.

Volume of Fill between cross sections are calculated by finding the average fill cross sectional area and multiplying it by the distance between the two cross sections. For example, the fill volume between cross sections A and B is calculated as follows:

$$\begin{aligned} \text{Average Fill Area} &= (\text{Fill Area "A"} + \text{Fill Area "B"})/2 = (0 \text{ ft}^2 + 100 \text{ ft}^2)/2 = 50 \text{ ft}^2 \\ \text{Volume of Fill} &= (\text{Average Fill Area}) \times (\text{Distance}) = (50 \text{ ft}^2) \times (150 \text{ ft}) = 7,500 \text{ ft}^3 \end{aligned}$$

Once the total volume of fill placed, for this example, between the 0-and 10-yr flood elevations is determined, the total required compensatory storage can be calculated and compared against the total compensatory storage volume provided by the design as shown in the table. For this example:

$$\text{Required Compensatory Storage} = (1) \times (\text{Total Volume of Fill}) = (1) \times (36,250 \text{ ft}^3) = 36,250 \text{ ft}^3$$

Figure 11-3- Example Compensatory Storage Grading Plan

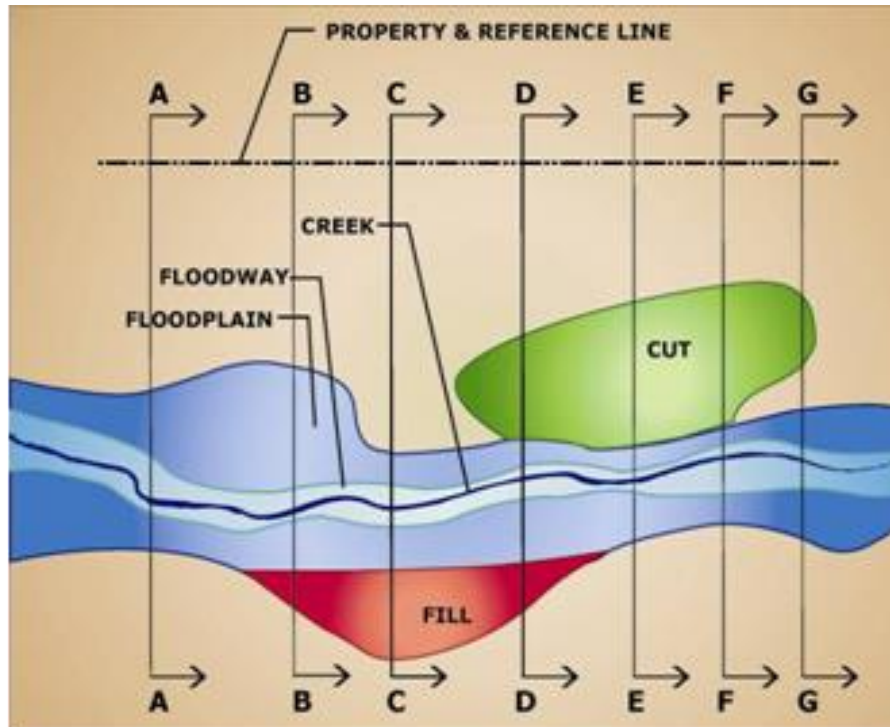

* Not to Scale & Topography not shown for clarity.

Figure 11-4 – Example Cross Section D-D

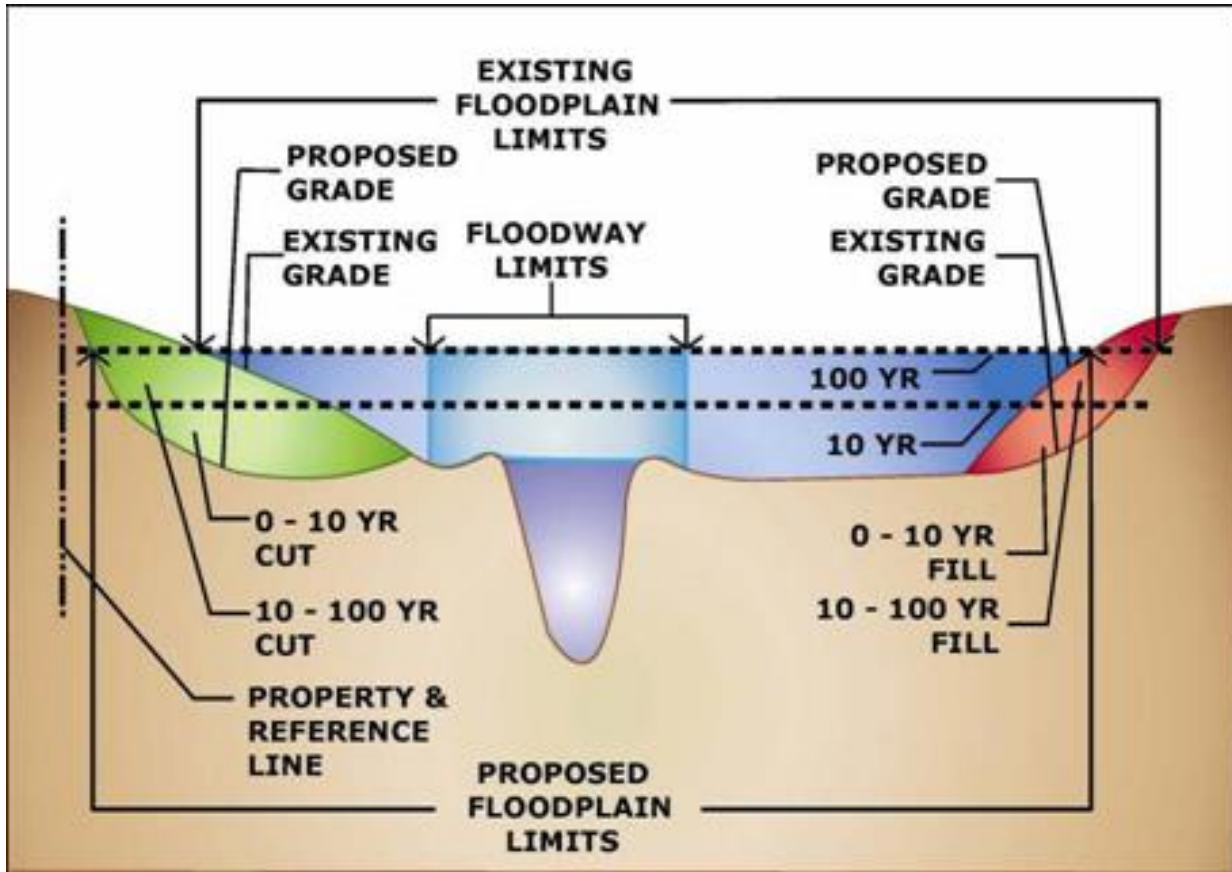

Table 11-1 - Example Compensatory Storage Calculations for 0-10 year event

| Cross Section | Distance Between Sections (ft.) | Fill Area (sq. ft.) | Average Fill Area (sq. ft.) | Volume of Fill (cu. Ft.) | Cut Area (sq. ft.) | Average Cut (sq. ft.) | Volume of Cut (cu. Ft.) |
|---------------|---------------------------------|---------------------|-----------------------------|--------------------------|--------------------|-----------------------|-------------------------|
| A | | 0 | | | 0 | | |
| B | 150 | 100 | 50 | 7,500 | 0 | 0 | |
| C | 90 | 150 | 125 | 11,250 | 40 | 20 | 1,800 |
| D | 100 | 100 | 125 | 12,500 | 90 | 65 | 6,500 |
| E | 100 | 100 | 50 | 5,000 | 90 | 100 | 10,000 |
| F | 100 | 0 | 0 | 0 | 110 | 120 | 12,000 |
| G | 85 | 0 | 0 | 0 | 130 | 85 | 7,225 |
| Total Fill | | | | 36,250 | Total Cut | | 37,525 |

Since the total amount of cut provided ($37,525 \text{ ft}^3$ as shown in the table) is larger than that required ($36,250 \text{ ft}^3$), the design meets the compensatory storage requirement for the 10-year flood. An additional table and calculation should be completed for the flood storage between the 10-year and

100-year plus 2 feet flood elevation in a similar manner to determine whether the design meets the compensatory storage requirement for the area above the 10-year flood elevation.

Location of Compensatory Storage

Compensatory storage must be located on-site and adjacent to or opposite the areas filled or occupied by a structure. In those rare instances when compensatory storage cannot be located adjacent to or opposite to the areas filled or occupied, engineering computations demonstrating that hydraulically equivalent compensatory storage has been provided in a nearby area in the watershed is required. These computations must show that no increase in flood flows or flood depths will result as a result of the location of the proposed compensatory storage.

Compensatory storage must be constructed to drain freely and openly to watercourses. In some rare cases it may be necessary to install pipes to construct and/or operate a compensatory storage basin. This may occur when site constraints, such as a roadway or sidewalk, separate the waterway from the compensatory storage area. This is illustrated in the top half of **Figure 11-5**.

Another scenario may occur when a site cannot meet the incremental storage requirements discussed in this document. If incremental storage requirements from the 10-year to 100-year plus 2 feet elevations cannot be met, pipes could be installed with a flap gate to prevent the water from entering from the stream bed at lower elevations. The berm could then be set at the elevation of the 10-year flood elevation, thus allowing the storage to only become effective above the 10-year flood elevation. This is illustrated in the bottom half of the illustration in Figure 11-5.

The use of pipes in compensatory storage will require approval by the County. Pipes must be a minimum of 15 inches in diameter so as to allow water to enter and exit freely with a minimum head differential. If the compensatory storage is proposed to be combined with detention, it must be demonstrated the compensatory storage and detention do not interfere with one another.

Figure 11-5 – Example of Compensatory Storage Connection to Stream through Pipe

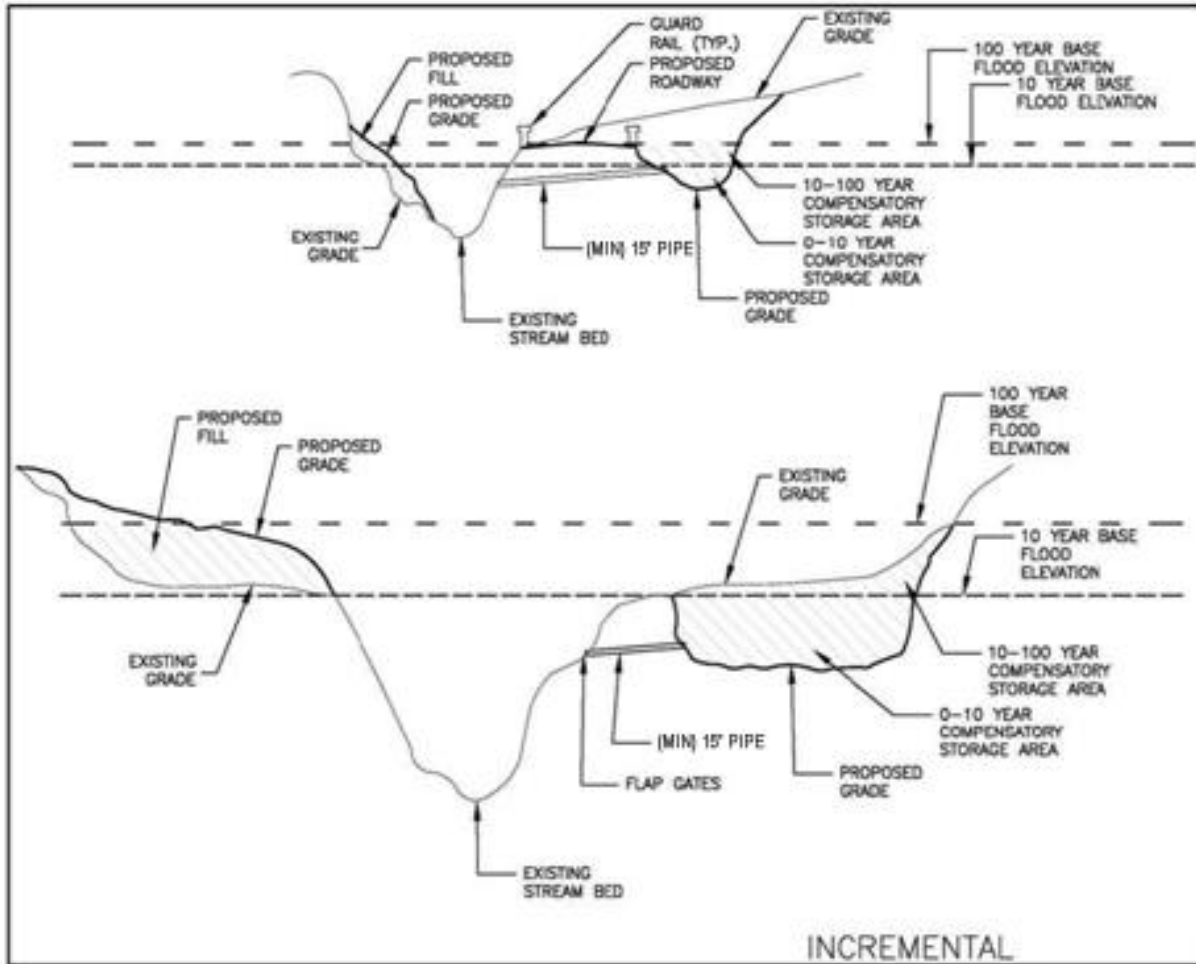

Compensatory Storage in the Regulatory Floodway

Only fill associated with appropriate uses of the regulatory floodway may be allowed to be placed within the limits of the floodway. When in rare circumstances, fill is allowed, all provisions discussed above relating to compensatory storage must be met in addition to the items discussed below.

- Any fill placed within the existing floodway must be compensated for within the proposed floodway.
- All floodway storage lost below the existing 10-year base flood elevation shall be replaced below the proposed 10-year base flood elevation.
- All floodway storage lost between the existing 10-year flood elevation and the existing 100-year plus 2 feet flood elevation shall be replaced between the proposed 10-year and proposed 100-year plus 2 feet flood elevation.

Should excavation within a floodway be allowed in special circumstances, there shall be no reduction in floodway surface area as a result of a floodway modification, unless such modification is part of a stream-wide plan or necessary to reduce flooding at an existing structure.



Chapter Nine

STANDARDS ASSOCIATED WITH DAMS AND LEVEES

A. POLICY ON DAMS AND LEVEES

Dams and levees have the potential for significant, sometimes catastrophic consequences should they fail. In order to minimize the potential for loss of life and public safety, decrease the potential for increased flood damage and disaster costs, and safeguard the downstream property rights, the following shall be required by Franklin County for any proposed new or improvements to any existing dam or levee. These requirements are in addition to what is normally required for other development subject to this Ordinance and/or that required by State or Federal agencies.

1. Design of dams shall follow the requirements of the latest edition of IDNR-Division of Water "General Guidelines for New Dams and Improvements to Existing Dams in Indiana" as well as principles provided in the latest edition of "Indiana Dam Safety Inspection Manual".
2. Design of levee/floodwalls shall follow the FEMA requirements and guidelines provided in 44 CFR Section 65.10 and USACE Engineer Manual 1110-2-193, Design and Construction of Levees.
3. An Incident and Emergency Action Plan (IEAP), including a detailed dam breach inundation map, shall be developed in accordance with the template provided in the latest edition of "Indiana Dam Safety Inspection Manual" and submitted to Franklin County. The detailed dam breach inundation map referenced in this paragraph shall be developed for both "Sunny Day Breach" Scenario (breach during normal loading conditions) and for maximum loading condition with breach assumed to occur as the spillway system is passing the Spillway Design Flood associated with the dam ("SDF + Breach" Scenario).
4. Unless the "Sunny Day Breach Inundation Area" is entirely contained within the applicant's property and/ or contained within the existing 100-year floodplain, a copy of recorded flood inundation easement or a recorded written consent for every property within the potential "Sunny Day Breach Inundation Area" shall be submitted to Franklin County. Also required is the ownership or recorded easement of all property around the lake with an elevation below the top of the dam. In addition, all the affected property owners whose properties are located within the "SDF + Breach Inundation Area" must be notified of a hearing relevant to the proposed added flooding risk, should such a man-made structure suffer a catastrophic failure. Notification of the time and place of the hearing shall be made in person or by certified mail at least five (5) to ten (10) days prior to the hearing. Proof of notice to each landowner shall be filed by affidavit with Franklin County prior to the hearing.

5. A copy of a Management and Maintenance Plan for the proposed dam or levee developed in accordance with the latest edition of "Indiana Dam Safety Inspection Manual" shall be submitted to Franklin County.
6. Unless the dam is subject to and regulated by IDNR, following the permitting and construction of the dam or levee, a copy of a formal periodic inspection report prepared in accordance with the recommendations contained in the latest edition of "Indiana Dam Safety Inspection Manual" shall be submitted to Franklin County along with evidence that the identified maintenance deficiencies have been corrected. The inspection report has to be submitted as it gets completed in accordance with the inspection frequency recommended in the latest edition of "Indiana Dam Safety Inspection Manual".

B. REQUIREMENTS ASSOCIATED WITH PROPOSED DEVELOPMENTS DOWNSTREAM OF DAMS

As indicated in the previous section, dams have the potential for significant, sometimes catastrophic consequences should they fail. Placing new development downstream of an existing dam does not only expose the future residents or users of the newly developed areas to a potential new significant risk, but could also have an impact on the hazard rating of the dam itself, which can in turn make the dam non-compliant with the state and federal standards. In order to minimize the potential for loss of life and public safety, decrease the potential for increased flood damage and disaster costs, and safeguard the upstream dam owner's rights, the following shall be required by Franklin County for any proposed new development or redevelopment downstream of an existing dam. These requirements are in addition to what is normally required for new development or redevelopment subject to these Standards.

1. Dam breach inundation maps have been created for several existing dams within the State of Indiana by the dam owners, IDNR, or others as part of development of individual IEAPs for these dams. When the development location is suspected by the applicant or Franklin County to be within an existing dam's breach inundation zone, the applicant is required to include a copy of the breach inundation mapping associated with that dam as part of its stormwater management permit application. To locate such a mapping, the applicant should contact the dam owner, IDNR- Division of Water, *Franklin County*, or other agencies to obtain the breach inundation map for the dam, if available. If no dam breach inundation map can be located for the dam, it will be the applicant's responsibility to produce a *Franklin County*-acceptable dam breach mapping either through directly contracting with a qualified engineer or through funding the production of such a map by the *Franklin County* review consultant in accordance with standards and guidelines established by the IDNR-Division of Water.
2. If the location of the proposed development falls within the dam breach inundation zone on the map discussed under Item i (above), additional requirements as determined by *Franklin County* may be imposed before a permit is issued and the development is allowed to occur. The noted additional requirements depend on several variables and are expected to vary case by case. Typical requirements could include relocating a portion or all of the proposed development to areas outside of the dam breach inundation zone, cost-sharing with the dam owner in necessary upgrades to the dam as a result of a potential hazard classification increase, addition of structural protection measures (such as flood protection levees), additional freeboard requirements, development and periodic exercise of warning and evacuation plans, and other measures considered necessary by *Franklin County* to minimize the potential for loss of life and

public safety, decrease the potential for increased flood damage and disaster costs, and safeguard the upstream dam owner's rights.



Chapter Ten

SPECIAL STANDARDS FOR PROPOSED SOLAR FARMS

Solar development has expanded over the last several years as Indiana and other states have invested in this important resource to further greenhouse gas emission reductions. The large amount of impervious surface inherent in the construction of a large-scale solar array entails challenges not encountered in traditional development projects. If not properly managed through appropriate design and mitigation measures, stormwater discharged during and after the construction of solar arrays can be a significant source of pollution resulting from increased runoff, erosion, and sedimentation, which can adversely impact adjoining properties, streams, wetlands, or other natural resources. Solar installations must be properly designed to assure soil stabilization, minimize soil disturbance and soil compaction, and address ineffective controls to manage the total runoff volume and velocity that can lead to the loss of topsoil, erosion and sediment discharges from disturbed areas and stormwater outlets, and erosion along downstream channels and streambanks. The ability to address such significant environmental problems during construction and post-construction becomes more difficult as site imperviousness increases.

Solar projects that use traditional elevated solar panels are unique because they contain an impervious surface (elevated solar panel) that often has a pervious surface (vegetation) underneath the panel. Stormwater runoff from solar projects is generated primarily from rain that falls on access roads, inverter pads, and solar panels. Water that falls off solar panels runs across the panel to the dripline, and eventually falls to the underlying surface. Some of this water will infiltrate and some will run-off downslope and eventually off site.

One of the most notable impacts that solar sites have on water quality is the potential for erosion and/or scour at the dripline. To minimize the erosion and/or scour at the dripline, the lowest vertical clearance of any solar array shall be no greater than 10 feet.

In addition to providing construction BMPs, Solar projects must adhere to the post-construction stormwater management requirements including peak flow control (detention) requirements described in Chapter 6. However, because solar farms—particularly the panels— have unique characteristics, not like constructing a building or road, they often inherently include stormwater disconnection features that qualifies them for recognition/credit afforded to the Stormwater Disconnection BMP, which similar to typical solar panel farms rely on maintaining sheet flow and infiltration in adequately-sized, vegetative areas receiving runoff. The Stormwater Disconnection BMP is detailed in OCRA Green Infrastructure Curriculum and Training resources web page: [Appendix-C-BMP-Fact-Sheets.pdf \(in.gov\)](#). Per recommendations from the Center for Watershed Protection, the following Stormwater Disconnection recognitions/credits are established as part of these standards for solar farms that meet the conditions stated in these standards:

- i. WQv: Up to 100% of the required Water Quality Volume, proportionate to the percentage of total disconnected area to total site impervious area, may be subtracted from the required WQv.

- ii. CPv: For determining the Channel Protection Volume (CPv), the post-construction CN for the impervious area treated by the stormwater disconnection BMP may be determined assuming the treated area is “wood in good condition” (for the next less infiltrating hydrologic soil group than the pre-construction hydrologic soil group, since the area underneath panels is assumed disturbed/compacted during construction).
- iii. Qp (2, 10, 100): For determining the peak flow controls (detention), the post-construction CN for the area treated by the stormwater disconnection BMP, needed for determining post-construction peak flows (Qp) for 2, 10, and 100-year storms, may be determined assuming the treated area is “wood in good condition” (for the next less infiltrating hydrologic soil group than the pre-construction hydrologic soil group, since the area underneath panels is assumed disturbed/compacted during construction).

In order for the solar farm developments to be eligible for Stormwater Disconnection BMP recognitions/credits, the following design and construction guidelines must be met (Items d and g are required for all proposed solar farms regardless of whether Stormwater Disconnection recognition/credit is being sought):

- i. Roadways, gravel surfaces, transformer pads, and level spreaders within the solar field are considered effective impervious cover for the purposes of calculating Water Quality Volume (WQv), Channel Protection Volume (CPv), and post-construction peak flows.
- ii. All solar panels in the array should also be considered additional effective impervious cover for the purposes of calculating the WQv, CPv, and post-construction peak flow unless ALL the following conditions are met:
 - a) The vegetated area receiving runoff between rows of solar panels is equal to or greater than the average width of the row of solar panels draining to the vegetated area.
 - b) Overall site conditions and solar panel configuration within the array are designed and constructed such that the runoff remains as sheet flow across the entire site. Design array to ensure a perpendicular layout of drip edge to slope direction or install devices such as a Level Spreader to ensure sheet flow from the drip edge. Level Spreaders shall be designed in accordance with the Level Spreader fact sheet contained in [Appendix-C-BMP-Fact-Sheets.pdf \(in.gov\)](#).
 - c) The following conditions are satisfied regarding the design of the post-construction slope of the site:
 - For slopes less than or equal to 5%, appropriate vegetation shall be established as indicated in **Figure 13-1**, below.
 - For slopes greater than 5%, but less than 10%, practices including, but not limited to, the use of level spreaders, infiltration trenches, or similar energy dissipating practices as described in **Figure 13-2**, below, shall be used to ensure long term sheet flow conditions.

- For slopes equal to or greater than 10% and less than 15%, the Plan includes specific engineered stormwater control measures, such as level spreaders, infiltration trenches, or similar energy dissipating practices, with detailed specifications that are designed to provide permanent stabilization and non-erosive conveyance of runoff to the property line of the site or downgradient from the site.
 - Slopes greater than 15% are not qualified for a stormwater disconnection recognition/credit.
- d) The lowest vertical clearance of the solar panels above the ground should not be greater than ten (10) feet. The panels should, however, be at an adequate height to support vegetative growth and maintenance beneath and between the panels. If the lowest vertical clearance of the solar panels above the ground is greater than ten (10) feet, non-vegetative control measures will be necessary to prevent/control erosion and scour along the drip line or otherwise provide energy dissipation from water running off the panels.
- e) Disconnecting impervious surfaces works best in undisturbed soils. To minimize disturbance and compaction, construction vehicles and equipment should avoid areas used for disconnection during installation of the solar panels. Hydrologic Soil Group D soils or soils that are compacted by construction equipment may need to be tilled to a depth of four to six inches and/or amended to increase permeability.
- f) Groundcover vegetation must be maintained in good condition in those areas receiving disconnected runoff. Areas receiving runoff should be protected (e.g., planting shrubs or trees along the perimeter) from future compaction. Vegetated areas shall not be subject to chemical fertilization or herbicides/pesticides except for those applications that are necessary to get vegetation established and which follow an approved Erosion and Sediment Pollution Control Plan.

To maximize the potential for infiltration and reduce maintenance, the use of native deep-rooted vegetative cover under the panels and between the panel rows is highly encouraged. To achieve a native deep-rooted vegetative cover, a mixture of perennial grasses and wildflowers is recommended with a diversity of forbs or flowering plants that bloom throughout the growing season. Blooming shrubs may also be used in buffer areas as appropriate for visual screening. Perennial vegetation (grasses and forbs) should be native to Indiana, but where appropriate to the vegetative management plan goals, may also include other naturalized and non-invasive species which provide habitat for pollinators and wildlife and/or other ecosystem services.

- g) A fifty (50) foot buffer should be maintained between any part of the solar array and any “watercourse” or “waterbody) as that term is defined in Appendix A of these standards. The buffer shall consist of undisturbed existing vegetation or native shrub plantings.
- h) Similar to other post-construction BMPs, the vegetated area underneath the panels, the vegetated area receiving runoff, and any buffer areas will need to be mapped, maintained in accordance with the stormwater Management operation and maintenance manual.

Depending on the layout and number of panels installed, the stormwater disconnection BMP may address some or all of the stormwater management requirements (WQv) for an individual project. Where the

imperviousness is high or there is other infrastructure (e.g., access roads, transformers), additional runoff may need to be treated.

A solar panel project should ideally be installed and placed outside of the floodplain or detention facilities. If proposed to be placed within a floodplain or in a dry detention facility, panels (all tilt positions) must be installed at or above the flood protection grade (2 feet above the BFE) or at or above the 100-year emergency overflow of the detention facility plus one foot. This includes all electrical systems associated with the panels. If the solar array project is proposed within floodway portion of the floodplain, the project shall also require a Construction in Floodway Permit from the IDNR.

Figure 13-1
Typical Solar Panel Installation with Slopes $\leq 5\%$

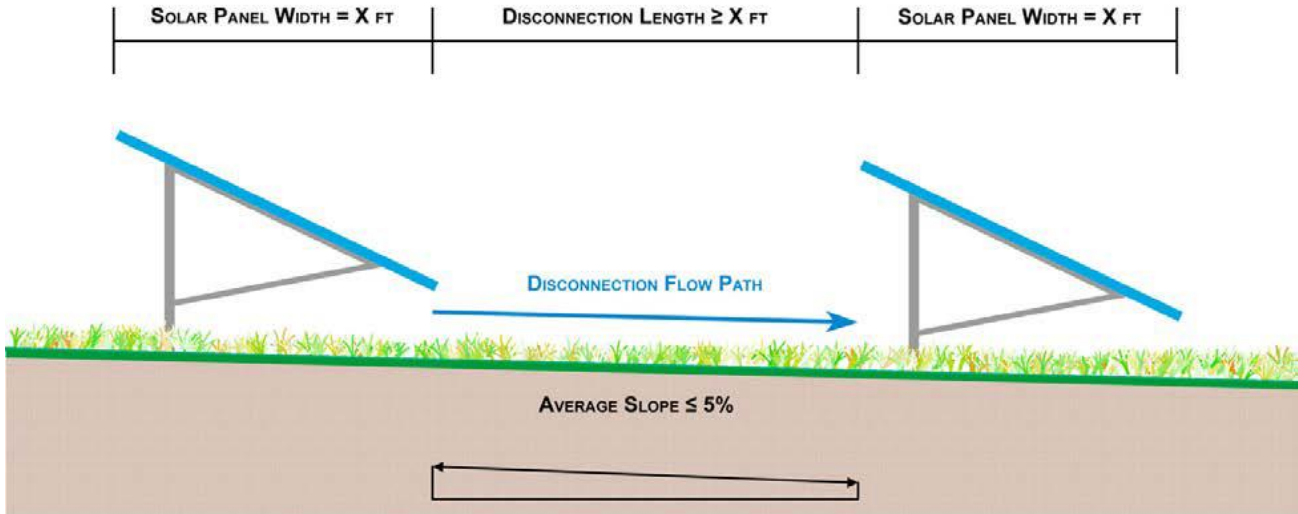
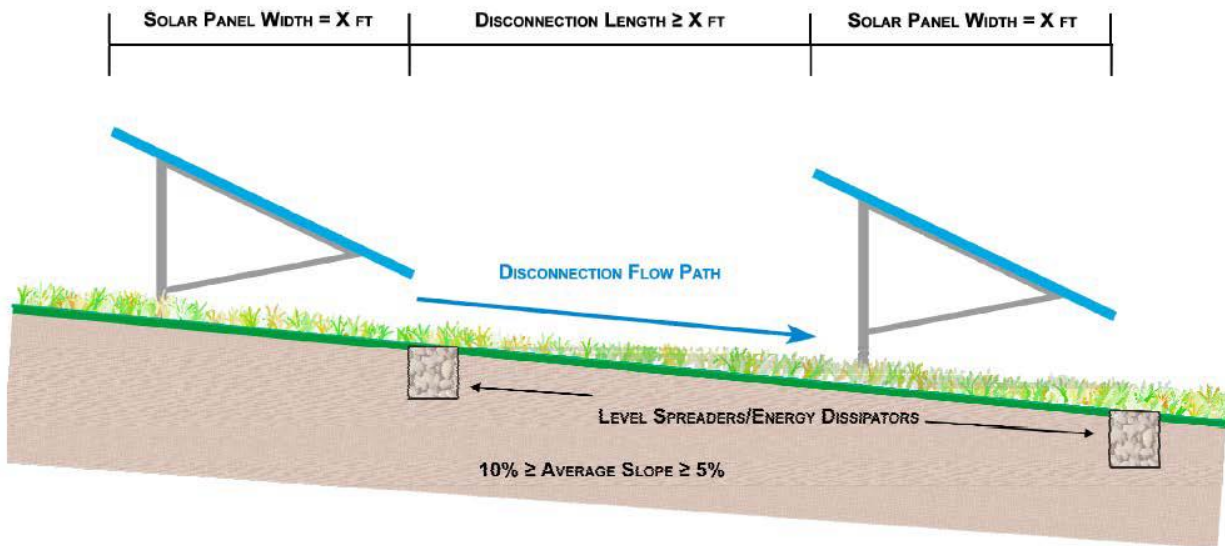

Figure 13-2
Typical Solar Panel Installation with Slopes $> 5\%$ and $\leq 10\%$



Source: Maryland Department of the Environment: Stormwater Design Guidance – Solar Panel Installations

APPENDIX A

ABBREVIATIONS AND DEFINITIONS



ABBREVIATIONS AND DEFINITIONS

ABBREVIATIONS

| | |
|-----------------|--|
| BFE | Base Flood Elevation |
| BMP | Best Management Practice |
| CFS | Cubic Feet Per Second |
| CLOMR | Conditional Letter of Map Revision (from FEMA) |
| CLOMR-F | Conditional Letter of Map Revision Based on Fill (from FEMA) |
| CN | Curve Number |
| COE | United States Army Corps of Engineers |
| CSMP | Comprehensive Stormwater Management Program |
| CSO | Combined Sewer Overflow |
| CWA | Clean Water Act |
| ERM | Elevation Reference Mark |
| E&SC | Erosion and Sediment Control |
| EPA | Environmental Protection Agency |
| ETJ | Extraterritorial Jurisdiction |
| FBFM | Flood Boundary and Floodway Map |
| FEH | Fluvial Erosion Hazard |
| FEMA | Federal Emergency Management Agency |
| FHBM | Flood Hazard Boundary Map |
| FIRM | Flood Insurance Rate Map |
| FIS | Flood Insurance Study |
| FPG | Flood Protection Grade |
| FPS | Feet Per Second |
| GIS | Geographical Information System |
| GPS | Global Positioning System |
| HGL | Hydraulic Grade Line |

| | |
|------------------|--|
| HHW | Household Hazardous Waste |
| HUC | Hydrologic Unit Code |
| IDEM | Indiana Department of Environmental Management |
| IDNR | Indiana Department of Natural Resources |
| INDOT | Indiana Department of Transportation. |
| LAG | Lowest Adjacent Grade |
| LID | Low Impact Development |
| LOMA | Letter of Map Amendment (from FEMA) |
| LOMR | Letter of Map Revision (from FEMA) |
| LOMR-F | Letter of Map Revision Based on Fill (from FEMA) |
| MCM | Minimum Control Measure |
| MS4 | Municipal Separate Storm Sewer System |
| NAVD | North American Vertical Datum of 1988 |
| NFIP | National Flood Insurance Program |
| NGVD 1929 | National Geodetic Vertical Datum of 1929 |
| NRCS | USDA-Natural Resources Conservation Service |
| NPDES | National Pollutant Discharge Elimination System |
| NPS | Non-point source |
| POTW | Publicly Owned Treatment Works |
| SFHA | Special Flood Hazard Area |
| SWCD | Soil and Water Conservation District |
| SWPPP | Stormwater Pollution Prevention Plan |
| SWQMP | Stormwater Quality Management Plan |
| Tc | Time of Concentration |
| TMDL | Total Maximum Daily Load |
| TN | Total Nitrogen |
| TP | Total Phosphorus |
| TSS | Total Suspended Solids |

| | |
|--------------|---|
| USCS | Unified Soil Classification System |
| USDA | United States Department of Agriculture |
| USFWS | United States Fish and Wildlife Service |

DEFINITIONS

Acre-Foot (AF). A measure of water volume equal to the inundation of a flat one-acre area to a depth of one foot (43,560 cubic feet).

Administering authority. The designated unit of government given the authority to issue permits.

Agricultural land disturbing activity. Tillage, planting, cultivation, or harvesting operations for the production of agricultural or nursery vegetative crops. The term also includes pasture renovation and establishment, the construction of agricultural conservation practices, and the installation and maintenance of agricultural drainage tile.

Agricultural land use conservation practices. Use of land for the production of animal or plant life, including forestry, pasturing or yarding of livestock, and planting, growing, cultivating, and harvesting crops for human or livestock consumption. Practices that are constructed on agricultural land for the purposes of controlling soil erosion and sedimentation. These practices include grass waterways, sediment basins, terraces, and grade stabilization structures.

Amortization Period. The length of time used to repay a debt or mortgage or to depreciate an initial cost.

Antecedent Runoff Condition. The index of runoff potential before a storm event. The index, developed by the Soil Conservation Service (SCS), is an attempt to account for the variation of the SCS runoff curve number (CN) from storm to storm.

Backflow Preventer. Device that allows liquids to flow in only one direction in a pipe. Backflow preventers are used on sewer pipes to prevent a reverse flow during flooding situations.

Backwater. The rise in water surface elevation caused by some obstruction such as a narrow bridge opening, buildings or fill material that limits the area through which the water shall flow.

Base Flood Elevation. The water surface elevation corresponding to a flood having a one percent probability of being equaled or exceeded in a given year.

Base Flood. See "Regulatory Flood".

Base Flow. Stream discharge derived from groundwater sources as differentiated from surface runoff. Sometimes considered to include flows from regulated lakes or reservoirs.

Basement. A building story that is all or partly underground but having at least one-half of its height below the average level of the adjoining ground. A basement shall not be counted as a story for the purpose of height regulations.

Benchmark. A marked point of known elevation from which other elevations may be established.

Best Management Practices. Design, construction, and maintenance practices and criteria for stormwater facilities that minimize the impact of stormwater runoff rates and volumes, prevent erosion, and capture pollutants.

Buffer Strip. An existing, variable width strip of vegetated land intended to protect water quality and habitat.

Building. See “structure”.

Capacity of a Storm Drainage Facility. The maximum flow that can be conveyed or stored by a storm drainage facility without causing damage to public or private property.

Catch Basin. A chamber usually built at the curb line of a street for the admission of surface water to a storm drain or subdrain, having at its base a sediment sump designed to retain grit and detritus below the point of overflow.

Centerline of Channel. The thalweg of a channel.

Channel Improvement. Alteration, maintenance, or reconstruction of the channel area for the purpose of improving the channel capacity or overall drainage efficiency. The noted "improvement" does not necessarily imply water quality or habitat improvement within the channel or its adjacent area.

Channel Modification. Alteration of a channel by changing the physical dimensions or materials of its bed or banks. Channel modification includes damming, rip-rapping or other armoring, widening, deepening, straightening, relocating, lining, and significant removal of bottom or woody vegetation. Channel modification does not include the clearing of dead or dying vegetation, debris, or trash from the channel. Channelization is a severe form of channel modification typically involving relocation of the existing channel (e.g., straightening).

Channel Stabilization. Protecting the sides and bed of a channel from erosion by controlling flow velocities and flow directions using jetties, drops, or other structures and/or by fining the channel with vegetation, riprap, concrete, or other suitable lining material.

Channel. A portion of a natural or artificial watercourse which periodically or continuously contains moving water, or which forms a connecting link between two bodies of water. It has a defined bed and banks which serve to confine the water.

Class V injection well. A type of well, which typically has a depth greater than its largest surface dimension, emplaces fluids into the subsurface, and does not meet the definitions of Class I through Class IV wells as defined under 40 CFR 146.5. While the term includes the specific examples described in 40 CFR 144.81, septic systems that serve more than one (1) single-family dwelling or provide service for non-domestic waste, dug wells, bored wells, improved sinkholes, french drains, infiltration sumps, and infiltration galleries, it does not include surface impoundments, trenches, or ditches that are wider than they are deep.

Closed Conduit. A pipe, tube, or tile used for transmitting water.

Combined Sewer Overflow. A system designed and used to receive and transport combined sewage so that during dry periods the wastewater is carried to a treatment facility. During storm events, the excess water is discharged directly into a river, stream, or lake without treatment.

Compensatory Storage. An artificial volume of storage within a floodplain used to balance the loss of natural flood storage capacity when artificial fill or substructures are placed within the floodplain.

Compost. Organic residue (or a mixture of organic residue and soil) that has undergone biological decomposition until it has become relatively stable humus.

Comprehensive Stormwater Management Program. A comprehensive stormwater program for effective management of stormwater quantity and quality throughout the community.

Constructed Wetland. A manmade shallow pool that creates growing conditions suitable for wetland vegetation and is designed to maximize pollutant removal.

Construction activity. Land disturbing activities, and land disturbing activities associated with the construction of infrastructure and structures. This term does not include routine ditch or road maintenance or minor landscaping projects.

Construction plan. A representation of a project site and all activities associated with the project. The plan includes the location of the project site, buildings and other infrastructure, grading activities, schedules for implementation and other pertinent information related to the project site. A storm water pollution prevention plan is a part of the construction plan.

Construction site access. A stabilized stone surface at all points of ingress or egress to a project site, for the purpose of capturing and detaining sediment carried by tires of vehicles or other equipment entering or exiting the project site.

Construction Support Activities. Include but are not limited to the following: concrete or asphalt batch plants, equipment staging yards, material storage areas, excavated material disposal areas, borrow areas. Such activities must not support multiple, unrelated projects, be a commercial/industrial operation, or continue to operate beyond the completion of the construction activity for the project it supports.

Contiguous. Adjoining or in actual contact with.

Contour Line. Line on a map which represents a contour or points of equal elevation.

Contour. An imaginary line on the surface of the earth connecting points of the same elevation.

Contractor or subcontractor. An individual or company hired by the project site or individual lot owner, their agent, or the individual lot operator to perform services on the project site.

Control Structure. A structure designed to control the rate of flow that passes through the structure, given a specific upstream and downstream water surface elevation.

Conveyance. Any structural method for transferring stormwater between at least two points. The term includes piping, ditches, swales, curbs, gutters, catch basins, channels, storm drains, and roadways.

Convolution. The process of translating precipitation excess into a runoff hydrograph.

Crawl Space. Low space below first floor of a house where there has not been excavation deep enough for a basement, usually less than seven (7) feet in depth, but where there is access for pipes, ducts, utilities and similar equipment.

Critical Duration Analysis. The process of testing different rainfall durations to find that “critical duration”, which produces the highest peak runoff or the highest storage volume.

Cross-Section. A graph or plot of ground elevation across a stream valley or a portion of it, usually along a line perpendicular to the stream or direction of flow.

Crown of Pipe. The elevation of top of pipe.

Cubic Feet Per Second (CFS). Used to describe the amount of flow passing a given point in a stream channel. One cubic foot per second is equivalent to approximately 7.5 gallons per second.

Culvert. A closed conduit used for the conveyance of surface drainage water under a roadway, railroad, canal or other impediment.

Curve Number (CN). The Soil Conservation Service index that represents the combined hydrologic effect of soil, land use, land cover, hydrologic condition and antecedent runoff condition.

Dam. A barrier to confine or impound water for storage or diversion, to prevent gully erosion, or to retain soil, sediment, or other debris.

Damage. Measurable rise in flood heights on buildings currently subject to flooding, flooding of buildings currently not subject to flooding and increases in volume or velocity to the point where the rate of land lost to erosion and scour is substantially increased.

Datum. Any level surface to which elevations are referred, usually Mean Sea Level.

Dechlorinated swimming pool discharge. Chlorinated water that has either sat idle for seven (7) days following chlorination prior to discharge to the MS4 conveyance, or, by analysis, does not contain detectable concentrations (less than five-hundredths (0.05) milligram per liter) of chlorinated residual.

Depressional Storage Areas. Non-riverine depressions in the earth where stormwater collects. The volumes are often referred to in units of acre-feet.

Design Storm. A selected storm event, described in terms of the probability of occurring once within a given number of years, for which drainage or flood control improvements are designed and built.

Detention Basin. A facility constructed or modified to restrict the flow of storm water to a prescribed maximum rate, and to detain concurrently the excess waters that accumulate behind the outlet.

Detention Facility. A facility designed to detain a specified amount of stormwater runoff assuming a specified release rate. The volumes are often referred to in units of acre-feet.

Detention Storage. The temporary detaining of storage of stormwater in storage facilities, on rooftops, in streets, parking lots, school yards, parks, open spaces or other areas under predetermined and controlled conditions, with the rate of release regulated by appropriately installed devices.

Detention Time. The theoretical time required to displace the contents of a tank or unit at a given rate of discharge (volume divided by rate of discharge).

Detention. Managing stormwater runoff by temporary holding and controlled release.

Detritus. Dead or decaying organic matter; generally contributed to stormwater as fallen leaves and sticks or as dead aquatic organisms.

Developer. Any person financially responsible for construction activity, or an owner of property who sells or leases, or offers for sale or lease, any lots in a subdivision.

Development. Any man-made change to improved or unimproved real estate including but not limited to:

1. Construction, reconstruction, or placement of a building or any addition to a building;
2. Construction of flood control structures such as levees, dikes, dams or channel improvements;
3. Construction or reconstruction of bridges or culverts;
4. Installing a manufactured home on a site, preparing a site for a manufactured home, or installing a recreational vehicle on a site for more than hundred eight (180) days;
5. Installing utilities, erection of walls, construction of roads, or similar projects;
6. Mining, dredging, filling, grading, excavation, or drilling operations;
7. Storage of materials; or
8. Any other activity that might change the direction, height, or velocity of flood or surface waters.

“Development” does not include activities such as the maintenance of existing buildings and facilities such as painting, re-roofing, resurfacing roads, or gardening, plowing and similar agricultural practices that do not involve filling, grading, excavation, or the construction of permanent buildings.

Direct Release. A method of stormwater management where runoff from a part or the entire development is released directly to the receiving stream without providing detention.

Discharge. In the context of water quantity provisions, usually the rate of water flow, i.e., a volume of fluid passing a point per unit time commonly expressed as cubic feet per second, cubic meters per second, gallons per minute, or millions of gallons per day. In the context of water quality provisions, the discharge means any addition of liquids or solids to a water body or a flow conveyance facility.

Disposal. The discharge, deposit, injection, spilling, leaking, or placing of any solid waste or hazardous waste into or on any land/or water so that the solid waste or hazardous waste, or any constituent of the waste, may enter the environment, be emitted into the air, or be discharged into any waters, including

Ditch. A man-made, open drainageway in or into which excess surface water or groundwater drained from land, stormwater runoff, or floodwaters flow either continuously or intermittently.

Drain. A buried slotted or perforated pipe or other conduit (subsurface drain) or a ditch (open drain) for carrying off surplus groundwater or surface water.

Drainage Area. The area draining into a stream at a given point. It may be of different sizes for surface runoff, subsurface flow and base flow, but generally the surface runoff area is considered as the drainage area.

Drainage Classification (soil). As a natural condition of the soil, drainage refers to both the frequency and duration of periods when the soil is free of saturation. Soil drainage conditions are defined as:

- *Well-drained*--Excess water drains away rapidly, and no mottling occurs within 36 inches of the surface.
- *Moderately well drained*--Water is removed from the soil somewhat slowly resulting in small but significant periods of wetness, and mottling occurs between 18 and 36 inches.
- *Poorly drained*--Water is removed so slowly that it is wet for a large part of the time, and mottling occurs between 0 and 8 inches.
- *Somewhat poorly drained*--Water is removed from the soil slowly enough to keep it wet for significant periods but not all of the time, and mottling occurs between 8 to 18 inches. *Very poorly drained*--Water is removed so slowly that the water table remains at or near the surface for the greater part of the time; there may also be periods of surface ponding; the soil has a black to gray surface layer with mottles up to the surface.

Drainage. The removal of excess surface water or groundwater from land by means of ditches or subsurface drains. Also see Natural drainage.

Drop Manhole. Manhole having a vertical drop pipe connecting the inlet pipe to the outlet pipe. The vertical drop pipe shall be located immediately outside the manhole.

Dry Well. A type of infiltration practice that allows stormwater runoff to flow directly into the ground via a bored or otherwise excavated opening in the ground surface.

Dry-Bottom Detention Basin. A basin designed to be completely dewatered after having provided its planned detention of runoff during a storm event.

Duration. The time period of a rainfall event.

Earth Embankment. A man-made deposit of soil, rock, or other material often used to form an impoundment.

Elevation Certificate. A form published by the Federal Emergency Management Agency that is used to certify the 100-year or base flood elevation and the lowest elevation of usable space to which a building has been constructed.

Elevation Reference Mark (ERM). Elevation benchmark tied to the National Geodetic Vertical Datum of 1929 and identified during the preparation of a Flood Insurance Study prepared for the Federal Emergency Management Agency.

Emergency Spillway. Usually, a vegetated earth channel used to safely convey flood discharges around an impoundment structure.

Energy Dissipater. A device to reduce the energy of flowing water.

Environment. The sum total of all the external conditions that may act upon a living organism or community to influence its development or existence.

Erosion and sediment control measure. A practice, or a combination of practices, to control erosion and resulting sedimentation. and/or off-site damages.

Erosion and sediment control system. The use of appropriate erosion and sediment control measures to minimize sedimentation by first reducing or eliminating erosion at the source and then as necessary, trapping sediment to prevent it from being discharged from or within a project site.

Erosion control plan. A written description and site plan of pertinent information concerning erosion control measures designed to meet the requirements of the Ordinance or these Standards.

Erosion. The wearing away of the land surface by water, wind, ice, gravity, or other geological agents. The following terms are used to describe different types of water erosion:

- *Accelerated erosion* -- Erosion much more rapid than normal or geologic erosion, primarily as a result of the activities of man.
- *Channel erosion* -- An erosion process whereby the volume and velocity of flow wears away the bed and/or banks of a well-defined channel.
- *Gully erosion* --An erosion process whereby runoff water accumulates in narrow channels and, over relatively short periods, removes the soil to considerable depths, ranging from 1-2 ft. to as much as 75-100 ft.
- *Rill erosion*--An erosion process in which numerous small channels only several inches deep are formed; occurs mainly on recently disturbed and exposed soils (see Rill).
- *Splash erosion*--The spattering of small soil particles caused by the impact of raindrops on wet soils; the loosened and spattered particles may or may not be subsequently removed by surface runoff.
- *Sheet erosion*--The gradual removal of a fairly uniform layer of soil from the land surface by runoff water.

Extraterritorial Jurisdiction (ETJ). Areas located outside the corporate limits of a community over which the community has statutory development authority.

Farm or Field Tile. A pipe installed in an agricultural area to allow subsurface drainage of farmland for the purpose of agricultural production.

FEMA. The Federal Emergency Management Agency.

Filter Strip. Usually a long, relatively narrow area (usually, 20-75 feet wide) of undisturbed or planted vegetation used near disturbed or impervious surfaces to filter stormwater pollutants for the protection of watercourses, reservoirs, or adjacent properties.

Final stabilization. The establishment of permanent vegetative cover or the application of a permanent non-erosive material to areas where all land disturbing activities have been completed and no additional land disturbing activities are planned under the current permit.

Floatable. Any solid waste that will float on the surface of the water.

Flood (or Flood Waters). A general and temporary condition of partial or complete inundation of normally dry land areas from the overflow, the unusual and rapid accumulation, or the runoff of surface waters from any source.

Flood Boundary and Floodway Map (FBFM). A map prepared by the Federal Emergency Management Agency that depicts the FEMA designated floodways within a community. This map also includes delineation of the 100-year and 500-year floodplain boundaries and the location of the Flood Insurance Study cross-sections.

Flood Crest. The maximum stage or elevation reached or expected to be reached by the waters of a specific flood at a given time.

Flood Duration. The length of time a stream is above flood stage or overflowing its banks.

Flood Easement. Easement granted to identify areas inundated by the 100-year flood and prohibit or severely restrict development activities.

Flood Elevation. The elevation at all locations delineating the maximum level of high waters for a flood of given return period.

Flood Fighting. Actions taken immediately before or during a flood to protect human life and to reduce flood damages such as evacuation, emergency sandbagging and diking.

Flood Forecasting. The process of predicting the occurrence, magnitude and duration of an imminent flood through meteorological and hydrological observations and analysis.

Flood Frequency. A statistical expression of the average time period between floods equaling or exceeding a given magnitude. For example, a 100-year flood has a magnitude expected to be equaled or exceeded on the average of once every hundred years; such a flood has a one-percent chance of being equaled or exceeded in any given year. Often used interchangeably with "recurrence interval".

Flood Hazard Area. Any floodplain, floodway, floodway fringe, or any combination thereof which is subject to inundation by the regulatory flood; or any flood plain as delineated by Zone X on a Flood Hazard Boundary Map.

Flood Hazard Boundary Map (FHBM). A map prepared by the Federal Emergency Management Agency that depicts Special Flood Hazard Areas as a Zone A within a community. There are no study text, base flood elevations, or floodways associated with this map.

Flood Insurance Rate Map (FIRM). A map prepared by the Federal Emergency Management Agency that depicts Special Flood Hazard Areas within a community. This map also includes the 100-year or Base Flood Elevation at various locations along the watercourses. More recent versions of the FIRM may also show the FEMA designated floodway boundaries and the location of the Flood Insurance Study cross-sections.

Flood Insurance Study (FIS). A study prepared by the Federal Emergency Management Agency to assist a community participating in the National Flood Insurance Program in its application of the program regulations. The study consists of a text which contains community background information with respect to flooding, a floodway data table, summary of flood discharges, flood profiles, a Flood Insurance Rate Map, and a Flood Boundary and Floodway Map.

Flood Profile. A graph showing the relationship of water surface elevation to a specific location, the latter generally expressed as distance above the mouth of a stream of water flowing in a channel. It is generally drawn to show surface elevation for the crest or a specific magnitude of flooding, but may be prepared for conditions at any given time or stage.

Flood Protection Grade (FPG). The elevation of the regulatory or 100-year flood plus two (2) feet of freeboard if the flooding source is a lake, pond, stream, or an open channel/ditch (or 1 foot of freeboard if the flooding source is an overflow path/ponding area provided that the elevation of the overflow path/ponding area is calculated based on the assumption of fully plugged storm pipe system).

Flood Resistant Construction (Flood Proofing). Additions, changes or adjustments to structures or property that are designed to reduce or eliminate the potential for flood damage.

Flood Storage Areas. Depressions, basins, or other areas that normally stand empty or partially empty, but fill with rainfall runoff during storms to hold the runoff and reduce downstream flow rates. The volumes are often referred to in units or acre-feet.

Floodplain Management. The operation of a program of corrective and preventive measures for reducing flood damage, including but not limited to flood control projects, floodplain land use regulations, flood proofing of buildings, and emergency preparedness plans.

Floodplain Regulations. General term applied to the full range of codes, ordinances and other regulations relating to the use of land and construction within floodplain limits. The term encompasses zoning ordinances, subdivision regulations, building and housing codes, encroachment laws and open area (space) regulations.

Floodplain. The channel proper and the areas adjoining the channel which have been or hereafter may be covered by the regulatory or 100-year flood. Any normally dry land area that is susceptible to being inundated by water from any natural source. The floodplain includes both the floodway and the floodway fringe districts.

Floodway Fringe. That portion of the flood plain lying outside the floodway, which is inundated by the regulatory flood.

Floodway. The channel of a river or stream and those portions of the floodplains adjoining the channel which are reasonably required to efficiently carry and discharge the peak flow of the regulatory flood of any river or stream.

Fluvial Erosion Hazard (FEH) Corridor. Fluvial (riverine) Erosion Hazard corridors represent the areas along the streams (including the channel and immediate overbanks areas) that are believed to be subject to stream movement or streambank erosion. These corridors have been delineated for most actively migrating and relatively stationary streams in Indiana through an Indiana Silver Jackets initiative, with data for *Franklin County* currently contained on the *Franklin County* GIS website. More detailed mapping than that used as part of the Indiana Silver Jackets erosion hazard mapping program may be provided by the applicant if it is based on detailed field assessment acceptable to Franklin County.

Footing Drain. A drain pipe installed around the exterior of a basement wall foundation to relieve water pressure caused by high groundwater elevation.

Forebay (or Sediment Forebay). A small pond placed in front of a larger retention/detention structure such as a wet pond, dry pond, or wetland to intercept and concentrate a majority of sediment that is coming into the system before it reaches the larger structure.

Freeboard. An increment of height added to the base flood elevation to provide a factor of safety for uncertainties in calculations, unknown local conditions, wave actions and unpredictable effects such as those caused by ice or debris jams. (See Flood Protection Grade).

French Drain. A drainage trench backfilled with a coarse, water-transmitting material; may contain a perforated pipe.

Gabion. An erosion control structure consisting of a wire cage or cages filled with rocks.

Garbage. All putrescible animal solid, vegetable solid, and semisolid wastes resulting from the processing, handling, preparation, cooking, serving, or consumption of food or food materials.

Geographical Information System. A computer system capable of assembling, storing, manipulation, and displaying geographically referenced information. This technology can be used for resource management and development planning.

Geotextile Fabric. A woven or non-woven, water-permeable synthetic material used to trap sediment particles, prevent the clogging of aggregates with fine grained soil particles, or as a separator under road aggregate.

Geotextile Liner. A synthetic, impermeable fabric used to seal impoundments against leaks.

Global Positioning System. A system that provides specially coded satellite signals that is processed by a receiver, which determines position, velocity, and time. The system is funded and controlled by the U.S. Department of Defense.

Grade. (1) The inclination or slope of a channel, canal, conduit, etc., or natural ground surface usually expressed in terms of the percentage the vertical rise (or fall) bears to the corresponding horizontal distance. (2) The finished surface of a canal bed, roadbed, top of embankment, or bottom of excavation; any surface prepared to a design elevation for the support of construction, such as paving or the laying of a conduit. (3) To finish the surface of a canal bed, roadbed, top of embankment, or bottom of excavation, or other land area to a smooth, even condition.

Grading. The cutting and filling of the land surface to a desired slope or elevation.

Grass. A member of the botanical family Graminae, characterized by blade-like leaves that originate as a sheath wrapped around the stem.

Grassed swale. A type of vegetative practice used to filter stormwater runoff via a vegetated, shallow-channel conveyance.

Grassed Waterway. A natural or constructed waterway, usually broad and shallow, covered with erosion-resistant grasses and used to conduct surface water from an area.

Ground Cover (horticulture). Low-growing, spreading plants useful for low-maintenance landscape areas.

Groundwater Recharge. The infiltration of water into the earth. It may increase the total amount of water stored underground or only replenish supplies depleted through pumping or natural discharge.

Groundwater. Accumulation of underground water, natural or artificial. The term does not include

Habitat. The environment in which the life needs of a plant or animal are supplied.

Hard Surface. See "Impervious Surface."

High Water. Maximum designed permitted, or regulated water level for an impoundment.

Household Hazardous Waste. Solid waste generated by households that is ignitable, toxic, reactive, corrosive, or otherwise poses a threat to human health or the environment.

Hydraulic Grade Line (HGL). For Channel flow, the HGL is equal to the water surface whereas for pressure flow it is the piezometric surface.

Hydraulics. A branch of science that deals with the practical application of the mechanics of water movement. A typical hydraulic study is undertaken to calculate water surface elevations.

Hydrodynamic Loads. Forces imposed on structures by floodwaters due to the impact of moving water on the upstream side of the structure, drag along its sides, and eddies or negative pressures on its downstream side.

Hydrograph. For a given point on a stream, drainage basin, or a lake, a graph showing either the discharge, stage (depth), velocity, or volume of water with respect to time.

Hydrologic Unit Code. A numeric United States Geologic Survey code that corresponds to a watershed area. Each area also has a text description associated with the numeric code.

Hydrology. The science of the behavior of water in the atmosphere, on the surface of the earth, and underground. A typical hydrologic study is undertaken to compute flow rates associated with specified flood events.

Hydrometeorologic. Water-related meteorological data such as rainfall or runoff.

Hydrostatic Loads. Those loads or pressures resulting from the static mass of water at any point of floodwater contact with a structure. They are equal in all direction and always act perpendicular to the surface on which they are applied. Hydrostatic loads can act vertically on structural members such as floors, decks and roofs, and can act laterally on upright structural members such as walls, piers, and foundations.

IDNR. Indiana Department of Natural Resources.

Illicit Discharge. Any discharge to a conveyance that is not composed entirely of stormwater except naturally occurring floatables, such as leaves or tree limbs.

Impact Areas. Areas defined or mapped that are unlikely to be easily drained because of one or more factors including but not limited to any of the following: soil type, topography, land where there is not adequate outlet, a floodway or floodplain, land within 75 feet of each bank of any regulated drain or within 75 feet from the centerline of any regulated tile ditch.

Impaired Waters. Waters that do not or are not expected to meet applicable water quality standards, as included on IDEM's CWA Section 303(d) List of Impaired Waters.

Impervious surface. Surfaces, such as pavement and rooftops, which prevent the infiltration of stormwater into the soil.

Individual building lot. A single parcel of land within a multi-parcel development.

Individual lot operator. A contractor or subcontractor working on an individual lot.

Individual lot owner. A person who has financial control of construction activities for an individual lot.

INDOT. Indiana Department of Transportation. Generally used here to refer to specifications contained in the publication "INDOT Standard Specifications."

Infiltration practices. Any structural BMP designed to facilitate the percolation of run-off through the soil to ground water. Examples include infiltration basins or trenches, dry wells, and porous pavement.

Infiltration. Passage or movement of water into the soil.

Infiltration Swales. A depressed earthen area that is designed to promote infiltration.

Inlet. An opening into a storm drain system for the entrance of surface storm water runoff, more completely described as a storm drain inlet.

Intermittent Stream. A stream which carries water a considerable portion of the time, but which ceases to flow occasionally or seasonally because bed seepage and evapotranspiration exceed the available water supply.

Invert. The inside bottom of a culvert or other conduit.

Junction Chamber. A converging section of conduit, usually large enough for a person to enter, used to facilitate the flow from one or more conduits into a main conduit.

Land Surveyor. A person licensed under the laws of the State of Indiana to practice land surveying.

Land-disturbing Activity. Any man-made change of the land surface, including removing vegetative cover that exposes the underlying soil, excavating, filling, transporting and grading.

Larger common plan of development or sale. A plan, undertaken by a single project site owner or a group of project site owners acting in concert, to offer lots for sale or lease; where such land is contiguous, or is known, designated, purchased or advertised as a common unit or by a common name, such land shall be presumed as being offered for sale or lease as part of a larger common plan. The term also includes phased or other construction activity by a single entity for its own use.

Lateral Storm Sewer. A drain that has inlets connected to it but has no other storm drain connected.

Life Cycle Cost. Cost based on the total cost incurred over the system life including research, development, testing, production, construction, operation, and maintenance. Costs are normally determined on present worth or equivalent annual cost basis.

Low Entry Elevation. The elevation in a structure where overbank flooding can enter the structure.

Lowest Adjacent Grade. The elevation of the lowest grade adjacent to a structure, where the soil meets the foundation around the outside of the structure (including structural members such as basement walkout, patios, decks, porches, support posts or piers, and rim of the window well).

Lowest Floor. Refers to the lowest of the following:

1. The top of the basement floor;
2. The top of the garage floor, if the garage is the lowest level of the building;
3. The top of the first floor of buildings constructed on a slab or of buildings elevated on pilings or constructed on a crawl space with permanent openings; or
4. The top of the floor level of any enclosure below an elevated building where the walls of the enclosure provide any resistance to the flow of flood waters unless:
 - a] The walls are designed to automatically equalize the hydrostatic flood forces on the walls by allowing for the entry and exit of flood waters, by providing a minimum of two opening (in addition to doorways and windows) having a total area of one (1) square foot for every two (2) square feet of enclosed area subject to flooding. The bottom of all such openings shall be no higher than one (1) foot above grade.
 - b] Such enclosed space shall be usable only for the parking of vehicles or building access.

Low Impact Development. LID is a land planning and engineering design approach with a goal of replicating the pre-development hydrologic regime of urban and developing watersheds. The primary goal of LID is to mimic a site's predevelopment hydrology by reducing the impervious surface, infiltrating, filtering, storing, evaporating, and detaining runoff close to its source.

Major Drainage System. Drainage system carrying runoff from an area of one or more square miles.

Manhole. Storm drain structure through which a person may enter to gain access to an underground storm drain or enclosed structure.

Manning Roughness Coefficient or Manning's "n" Value. A dimensionless coefficient ("n") used in the Manning's equation to account for channel wall frictional losses in steady uniform flow.

Measurable storm event. A precipitation event that results in a total measured precipitation accumulation equal to, or greater than, one-half (0.5) inch of rainfall.

Minimum Control Measure. Minimum measures required by the NPDES Phase II program. The six (6) MCMs are: Public education and outreach, Public participation and involvement, Illicit discharge detection and elimination, Construction site runoff control, Post-construction runoff control, and Pollution prevention and good housekeeping.

Minor Drainage Systems. Drainage system carrying runoff from an area of less than one square mile.

Minor Subdivision. See Subdivision, Minor.

Mulch. A natural or artificial layer of plant residue or other materials covering the land surface which conserves moisture, holds soil in place, aids in establishing plant cover, and minimizes temperature fluctuations.

Multi-Family. Any structure which contains three or more dwelling units. A dwelling unit is any structure, or part of a structure, which is constructed to a house a family.

Municipal Separate Storm Sewers. An MS4 meets all the following criteria: (1) is a conveyance or system of conveyances owned by the state, county, City, or other public entity; (2) discharges to waters of the U.S.; (3) is designed or used for collecting or conveying stormwater; (4) is not a combined sewer; and, (5) is not part of a Publicly Owned Treatment Works (POTW).

Municipal, state, federal, or institutional refueling area. An operating gasoline or diesel fueling area whose primary function is to provide fuel to either municipal, state, federal, or institutional equipment or vehicles.

Mutual Drain. A drain that: (1) Is located on two or more tracts of land that are under different ownership; (2) was established by the mutual consent of all the owners; and (3) was not established under or made subject to any drainage statute.

National Flood Insurance Program (NFIP). The NFIP is a federal program enabling property owners to purchase flood insurance. The Federal Emergency Management Agency administers the NFIP in communities throughout the United States. The NFIP is based on an agreement between local communities and the Federal government which states that if a community will implement floodplain management measures to reduce future flood risks to new construction and substantially improved structures in flood hazard areas, the Federal government will make flood insurance available within the community as a financial protection against flood losses that do occur.

National Geodetic Vertical Datum of 1929. The nationwide, Federal Elevation datum used to reference topographic elevations to a known value.

National Pollution Discharge Elimination System (NPDES). A permit developed by the U.S. EPA through the Clean Water Act. In Indiana, the permitting process has been delegated to IDEM. This permit covers aspects of municipal stormwater quality.

Natural Drainage. The flow patterns of stormwater run-off over the land in its pre-development state.

Nonagricultural land use. Commercial use of land for the manufacturing and wholesale or retail sale of goods or services, residential or institutional use of land intended primarily to shelter people, highway use of land including lanes, alleys, and streets, and other land uses not included in agricultural land use.

Nonpoint Source Pollution. Pollution that enters a water body from diffuse origins on the watershed and does not result from discernable, confined, or discrete conveyances.

Normal Depth. Depth of flow in an open conduit during uniform flow for the given conditions.

North American Vertical Datum of 1988 (NAVD 1988). The nationwide, Federal Elevation datum used to reference topographic elevations to a known value.

Nutrient(s). (1) A substance necessary for the growth and reproduction of organisms. (2) In water, those substances (chiefly nitrates and phosphates) that promote growth of algae and bacteria.

Off-site. Everything not located at or within a particular site.

Off-site Land Areas. Those areas that by virtue of existing topography naturally shed surface water onto or through the developing property.

100-Year Frequency Flood. See "regulatory flood".

On-Site. Located within the controlled or urbanized area where runoff originates.

Open Drain. A natural watercourse or constructed open channel that conveys drainage water.

Open Space. Any land area devoid of any disturbed or impervious surfaces created by industrial, commercial, residential, agricultural, or other manmade activities.

Orifice. A device which controls the rate of flow from a detention basin.

Outfall scouring. The deterioration of a streambed or lakebed from an outfall discharge to an extent that the excessive settling of solid material results and suitable aquatic habitat is diminished.

Outfall. The point, location, or structure where a pipe or open drain discharges to a receiving body of water.

Outlet. The point of water disposal from a stream, river, lake, tidewater, or artificial drain.

Overland Flow. Consists of sheet flow, shallow concentrated flow and channel flow.

Peak Discharge (or Peak Flow). The maximum instantaneous flow from a given storm condition at a specific location.

Percolation. The movement of water through soil.

Perennial Stream. A stream that maintains water in its channel throughout the year.

Permanent stabilization. The establishment, at a uniform density of seventy percent (70%) across the disturbed area, of vegetative cover or permanent non-erosive material that will ensure the resistance of the soil to erosion, sliding, or other movement.

Permeability (soil). The quality of a soil that enables water or air to move through it. Usually expressed in inches per hour or inches per day.

Pervious. Allowing movement of water.

Pesticides. Chemical compounds used for the control of undesirable plants, animals, or insects. The term includes insecticides, herbicides, algicides, rodenticides, nematocides, fungicides, and growth regulators.

pH. A numerical measure of hydrogen ion activity, the neutral point being 7.0. All pH values below 7.0 are acid, and all above 7.0 are alkaline.

Phasing of construction. Sequential development of smaller portions of a large project site, stabilizing each portion before beginning land disturbance on subsequent portions, to minimize exposure of disturbed land to erosion.

Phosphorus (available). Inorganic phosphorus that is readily available for plant growth.

Piping. The formation of "pipes" by underground erosion. Water in the soil carries the fine soil particles away, and a series of eroded tubes or tunnels develop. These openings will grow progressively larger and can cause a dam failure.

Planimetric Data. Horizontal measurements involving distances or dimensions on a diagram, map, Plat of Survey or topographic map. Normally in units of feet.

Plat of Survey. A scaled diagram showing boundaries of a tract of land/or subdivision. This may constitute a legal description of the land and be used in lieu of a written description.

Point Source. Any discernible, confined, and discrete conveyance including but not limited to any pipe, ditch, channel, tunnel, conduit, well, discrete fissure, or container from which pollutants are or maybe discharged (P.L. 92-500, Section 502[14]).

Pollutant of concern. Any pollutant that has been documented via analytical data as a cause of impairment in any waterbody.

Porosity. The volume of pore space in soil or rock.

Porous pavement. A type of infiltration practice to improve the quality and reduce the quantity of storm water run-off via the use of manmade, pervious pavement which allows run-off to percolate through the pavement and into underlying soils

Private Drain. A drain that: (1) Is located on land owned by one person or by two or more persons jointly; and (2) was not established under or made subject to any drainage statute.

Professional Engineer. A person licensed under the laws of the State of Indiana to practice professional engineering.

Programmatic Indicator. Any data collected by an MS4 entity that is used to indicate implementation of one (1) or more minimum control measures.

Project site owner. The person required to submit a stormwater permit application and required to comply with the terms of the ordinance or these Technical Standards, including a developer or a person who has financial and operational control of construction activities, and project plans and specifications, including the ability to make modifications to those plans and specifications.

Project site. The entire area on which construction activity is to be performed.

Probable Maximum Flood. The most severe flood that may be expected from a combination of the most critical meteorological and hydrological conditions that are reasonably possible in the drainage basin. It is used in designing high-risk flood protection works and citing of structures and facilities that shall be subject to almost no risk of flooding. The probable maximum flood is usually much larger than the 100-year flood.

Publicly Owned Treatment Works (POTW). A municipal operation that breaks down and removes contaminants in the wastewater prior to discharging to a stream through primary and/or secondary treatment systems.

Qualified professional. An individual who is trained and experienced in storm water treatment techniques and related fields as may be demonstrated by state registration, professional certification, experience, or completion of coursework that enable the individual to make sound, professional judgments regarding storm water control or treatment and monitoring, pollutant fate and transport, and drainage planning.

Radius of Curvature. Length of radius of a circle used to define a curve.

Rain garden. A vegetative practice used to alter impervious surfaces, such as roofs, into pervious surfaces for absorption and treatment of rainfall.

Rainfall Intensity. The rate at which rain is falling at any given instant, usually expressed in inches per hour.

Reach. Any length of river, channel or storm drain.

Receiving Stream or Receiving Water. The body of water into which runoff or effluent is discharged. The term does not include private drains, unnamed conveyances, retention and detention basins, or constructed wetlands used as treatment.

Recharge. Replenishment of groundwater reservoirs by infiltration and transmission from the outcrop of an aquifer or from permeable soils.

Recurrence Interval. A statistical expression of the average time between floods equaling or exceeding a given magnitude.

Redevelopment. Alterations of a property that change a site or building in such a way that there is disturbances of one (1) acre or more of land. The term does not include such activities as exterior remodeling.

Regional Pond. A detention/retention basin sized to detain/retain the runoff from the entire watershed, on-site and off-site, tributary to the pond's outlet.

Regulated Area. Area under the stormwater regulatory jurisdiction of Franklin County.

Regulated Drain. A drain subject to the provisions of the Indiana Drainage Code, I.C.-36-9-27.

Regulatory or 100-Year Flood. The discharge or elevation associated with the 100-year flood as calculated by a method and procedure which is acceptable to and approved by the Indiana Department of Natural Resources and the Federal Emergency Management Agency. The "regulatory flood" is also known as the "base flood".

Regulatory Floodway. See Floodway.

Release Rate - The amount of storm water release from a storm water control facility per unit of time.

Reservoir. A natural or artificially created pond, lake or other space used for storage, regulation or control of water. May be either permanent or temporary. The term is also used in the hydrologic modeling of storage facilities.

Retail gasoline outlet. An operating gasoline or diesel fueling facility whose primary function is the resale of fuels. The term applies to facilities that create five thousand (5,000) or more square feet of impervious surfaces, or generate an average daily traffic count of one hundred (100) vehicles per one thousand (1,000) square feet of land area.

Retention basin. A type of storage practice, that has no positive outlet, used to retain storm water run-off for an indefinite amount of time. Runoff from this type of basin is removed only by infiltration through a porous bottom or by evaporation.

Retention. The storage of stormwater to prevent it from leaving the development site. May be temporary or permanent.

Retention Facility. A facility designed to completely retain a specified amount of stormwater runoff without release except by means of evaporation, infiltration or pumping. The volumes are often referred to in units of acre-feet.

Return Period - The average interval of time within which a given rainfall event will be equaled or exceeded once. A flood having a return period of 100 years has a one percent probability of being equaled or exceeded in any one year.

Revetment. Facing of stone or other material, either permanent or temporary, placed along the edge of a stream to stabilize the bank and protect it from the erosive action of the stream. Also see Revetment riprap.

Right-of-Way for a County Drain. The statutory right of way as defined by Indiana Code for a regulated drain.

Riparian habitat. A land area adjacent to a waterbody that supports animal and plant life associated with that waterbody.

Riparian zone. Of, on, or pertaining to the banks of a stream, river, or pond.

Riprap. Broken rock, cobble, or boulders placed on earth surfaces, such as the face of a dam or the bank of a stream, for protection against the action of water (waves). Revetment riprap is material graded such that: (1) no individual piece weighs more than 120 lbs. and (2) 90-100% will pass through a 12-inch sieve, 20-60% through a 6-inch sieve, and not more than 10% through a 12-inch sieve.

River Restoration. Restoring the channel of a stream or ditch to its perceived original, non-obstructed capacity by means of clearing & snagging, obstruction removal, and inexpensive streambank protection measures. The term "restoration", as noted, does not necessarily imply restoration or improvement of water quality or habitat within the channel or its adjacent area.

Riverine. Relating to, formed by, or resembling a stream (including creeks and rivers).

Runoff Coefficient - A decimal fraction relating the amount of rain which appears as runoff and reaches the storm drain system to the total amount of rain falling. A coefficient of 0.5 implies that 50 percent of the rain falling on a given surface appears as storm water runoff.

Runoff. That portion of precipitation that flows from a drainage area on the land surface, in open channels, or in stormwater conveyance systems.

Sand. (1) Soil particles between 0.05 and 2.0 mm in diameter. (2) A soil textural class inclusive of all soils that are at least 70% sand and 15% or less clay.

Sanitary Backup. The condition where a sanitary sewer reaches capacity and surcharges into the lowest area.

Scour. The clearing and digging action of flowing water.

Sediment. Solid material (both mineral and organic) that is in suspension, is being transported, or has been moved from its site of origin by air, water, gravity, or ice and has come to rest on the earth's surface.

Sediment Forebay. See "Forebay".

Sedimentation. The process that deposits soils, debris and other unconsolidated materials either on the ground surfaces or in bodies of water or watercourses.

Seepage. The passage of water or other fluid through a porous medium, such as the passage of water through an earth embankment or masonry wall.

Sensitive Water. A water body in need of priority protection or remediation based on its:

providing habitat for threatened or endangered species,

usage as a public water supply intake,

relevant community value,

usage for full body contact recreation,

exceptional use classification as found in 327 IAC 2-1-11(b), outstanding state resource water classification as found in 327 IAC 2-1-2(3) and 327 IAC 2-1.5-19(b).

Settling Basin. An enlargement in the channel of a stream to permit the settling of debris carried in suspension.

Silt Fence. A fence constructed of wood or steel supports and either natural (e.g. burlap) or synthetic fabric stretched across area of non-concentrated flow during site development to trap and retain on-site sediment due to rainfall runoff.

Silt. (1) Soil fraction consisting of particles between 0.002 and 0.05 mm in diameter. (2) A soil textural class indicating more than 80% silt.

Siphon - A closed conduit or portion of which lies above the hydraulic grade line, resulting in a pressure less than atmospheric and requiring a vacuum within the conduit to start flow. A siphon utilizes atmospheric pressure to effect or increase the flow of water through a conduit. An inverted siphon is used to carry storm water flow under an obstruction such as a sanitary sewer.

Site. The entire area included in the legal description of the land on which land disturbing activity is to be performed.

Silvicultural. the practice of controlling the establishment, growth, composition, health, and quality of forests to meet diverse needs and values.

1. Nonpoint activities include source silvicultural activities such as nursery operations, site preparation, reforestation and subsequent cultural treatment, thinning, prescribed burning, pest and fire control,

harvesting operations, surface drainage, or road construction and maintenance from which there is natural runoff. Some of these activities (such as stream crossing for roads) may involve the placement of dredged or fill material which may require a CWA section 404 permit and a 401 Water Quality Certification.

2. Point source activities include any discernible, confined and discrete conveyance related to rock crushing, gravel washing, log sorting, or log storage facilities which are operated in connection with silvicultural activities and from which pollutants are discharged into waters of the United States or the State.

Slope. Degree of deviation of a surface from the horizontal, measured as a numerical ratio or percent. Expressed as a ratio, the first number is commonly the horizontal distance (run) and the second is the vertical distance (rise)--e.g., 2:1. However, the preferred method for designation of slopes is to clearly identify the horizontal (H) and vertical (V) components (length (L) and Width (W) components for horizontal angles). Also note that according to international standards (Metric), the slopes are presented as the vertical or width component shown on the numerator--e.g., 1V:2H. Slope expressions in the Ordinance or these Technical Standards follow the common presentation of slopes--e.g., 2:1 with the metric presentation shown in parenthesis--e.g., (1V:2H). Slopes can also be expressed in "percent". Slopes given in percent are always expressed as $(100 \cdot V/H)$ --e.g., a 2:1 (1V:2H) slope is a 50% slope.

Soil and Water Conservation District. A public organization created under state law as a special-purpose district to develop and carry out a program of soil, water, and related resource conservation, use, and development within its boundaries. A subdivision of state government with a local governing body, established under IC 14-32.

Soil. The unconsolidated mineral and organic material on the immediate surface of the earth that serves as a natural medium for the growth of land plants.

Solid Waste. Any garbage, refuse, debris, or other discarded material.

Special Flood Hazard Area. An area that is inundated during the 100-Year flood.

Spill. The unexpected, unintended, abnormal, or unapproved dumping, leakage, drainage, seepage, discharge, or other loss of petroleum, hazardous substances, extremely hazardous substances, or objectionable substances. The term does not include releases to impervious surfaces when the substance does not migrate off the surface or penetrate the surface and enter the soil.

Spillway - A waterway in or about a hydraulic structure, for the escape of excess water.

Standard Project Flood. A term used by the U.S. Army Corps of Engineers to designate a flood that may be expected from the most severe combination of meteorological and hydrological conditions that are considered reasonable characteristics of the geographical area in which the drainage basin is located, excluding extremely rare combinations. The peak flow for a standard project flood is generally 40 – 60 percent of the probable maximum flood for the same location.

Stilling Basin - A basin used to slow water down or dissipate its energy.

Storage practices. Any structural BMP intended to store or detain stormwater and slowly release it to receiving waters or drainage systems. The term includes detention and retention basins.

Storm drain signing. Any marking procedure that identifies a storm sewer inlet as draining directly to a receiving waterbody so as to avoid dumping pollutants. The procedures can include painted or cast messages and adhesive decals.

Storm Duration. The length of time that water may be stored in any stormwater control facility, computed from the time water first begins to be stored.

Storm Event. An estimate of the expected amount of precipitation within a given period of time. For example, a 10-yr. frequency, 24-hr. duration storm event is a storm that has a 10% probability of occurring in any one year. Precipitation is measured over a 24-hr. period.

Storm Frequency. The time interval between major storms of predetermined intensity and volumes of runoff--e.g., a 5-yr., 10-yr. or 20-yr. storm.

Storm Sewer. A closed conduit for conveying collected storm water, while excluding sewage and industrial wastes. Also called a storm drain.

Stormwater Drainage System - All means, natural or man-made, used for conducting storm water to, through or from a drainage area to any of the following: conduits and appurtenant features, canals, channels, ditches, storage facilities, swales, streams, culverts, streets and pumping stations.

Stormwater Facility. All ditches, channels, conduits, levees, ponds, natural and manmade impoundments, wetlands, tiles, swales, sewers and other natural or artificial means of draining surface and subsurface water from land.

Stormwater Pollution Prevention Plan. A plan developed to minimize the impact of storm water pollutants resulting from construction activities.

Stormwater Quality Management Plan. A comprehensive written document that addresses stormwater runoff quality.

Stormwater Quality Measure. A practice, or a combination of practices, to control or minimize pollutants associated with storm water runoff.

Stormwater runoff. The water derived from rains falling within a tributary basin, flowing over the surface of the ground or collected in channels or conduits.

Stormwater. Water resulting from rain, melting or melted snow, hail, or sleet.

Stream Gauging. The quantitative determination of streamflow using gauges, current meters, weirs, or other measuring instruments at selected locations (see Gauging station').

Stream Length. The length of a stream or ditch, expressed in miles, from the confluence of the stream or ditch with the receiving stream to the upstream extremity of the stream or ditch, as indicated by the solid or dashed, blue or purple line depicting the stream or ditch on the most current edition of the seven and one-half (72) minute topographic quadrangle map published by the United States Geological Survey, measured along the meanders of the stream or ditch as depicted on the map.

Stream. See intermittent stream, Perennial stream, Receiving stream.

Streambanks. The usual boundaries (not the flood boundaries) of a stream channel. Right and left banks are named facing downstream.

Strip development. A multi-lot project where building lots front on an existing road.

Structure. Refers to a structure that is principally above ground and is enclosed by walls and a roof. The term includes but is not limited to, a gas or liquid storage tank, a manufactured home or a prefabricated building, and recreational vehicles to be installed on a site for more than 180 days.

Structural Engineer. A person licensed under the laws of the State of Indiana to engage in the designing or supervising of construction, enlargement or alteration of structures or any part thereof.

Structural Floodplain. Management Measures. Those physical or engineering measures employed to modify the way floods behave, (e.g., dams, dikes, levees, channel enlargements and diversions).

Subarea/Sub-basin. Portion of a watershed divided into homogenous drainage units which can be modeled for purposes of determining runoff rates. The subareas/sub-basins have distinct boundaries, as defined by the topography of the area.

Subdivision. Any land that is divided or proposed to be divided into lots, whether contiguous or subject to zoning requirements, for the purpose of sale or lease as part of a larger common plan of development or sale.

Subdivision, Minor. The subdivision of a parent parcel into any combination of not more than three (3) contiguous or non-contiguous new residential, commercial, or industrial building sites. The parcel shall front upon an existing street which is an improved right-of-way maintained by the County or other governmental entity and not involve any new street.

Subsoil. The B horizons of soils with distinct profiles. In soils with weak profile development, the subsoil can be defined as the soil below which roots do not normally grow.

Subsurface Drain. A pervious backfield trench, usually containing stone and perforated pipe, for intercepting groundwater or seepage.

Subwatershed. A watershed subdivision of unspecified size that forms a convenient natural unit. See also Subarea.

Sump Failure. A failure of the sump pump that results in inundation of crawl space or basement.

Sump Pump. A pump that discharges seepage from foundation footing drains.

Surcharge. Backup of water in a sanitary or storm sewer system in excess of the design capacity of the system.

Surface Runoff. Precipitation that flows onto the surfaces of roofs, streets, the ground, etc., and is not absorbed or retained by that surface but collects and runs off.

Suspended Solids. Solids either floating or suspended in water.

Swale. An elongated depression in the land surface that is at least seasonally wet, is usually heavily vegetated, and is normally without flowing water. Swales conduct stormwater into primary drainage channels and may provide some groundwater recharge.

Tailwater. The water surface elevation at the downstream side of a hydraulic structure (i.e. culvert, bridge, weir, dam, etc.).

Temporary Stabilization. The covering of soil to ensure its resistance to erosion, sliding, or other movement. The term includes vegetative cover, anchored mulch, or other non-erosive material applied at a uniform density of seventy percent (70%) across the disturbed area.

Thalweg. The deepest point (or centerline) of a channel.

Tile Drain. Pipe made of perforated plastic, burned clay, concrete, or similar material, laid to a designed grade and depth, to collect and carry excess water from the soil.

Tile Drainage. Land drainage by means of a series of tile lines laid at a specified depth, grade, and spacing.

Time of Concentration (tc). The travel time of a particle of water from the most hydraulically remote point in the contributing area to the point under study. This can be considered the sum of an overland flow time and times of travel in street gutters, storm sewers, drainage channels, and all other drainage ways.

Topographic Map. Graphical portrayal of the topographic features of a land area, showing both the horizontal distances between the features and their elevations above a given datum.

Topography. The representation of a portion of the earth's surface showing natural and man-made features of a given locality such as rivers, streams, ditches, lakes, roads, buildings and most importantly, variations in ground elevations for the terrain of the area.

Topsoil. (1) The dark-colored surface layer, or a horizon, of a soil; when present it ranges in depth from a fraction of an inch to 2-3 ft. (2) Equivalent to the plow layer of cultivated soils. (3) Commonly used to refer to the surface layer(s), enriched in organic matter and having textural and structural characteristics favorable for plant growth.

Total Maximum Daily Load. Method used to establish allowable loadings for specified pollutants in a surface water resource to meet established water quality standards.

Toxicity. The characteristic of being poisonous or harmful to plant or animal life. The relative degree or severity of this characteristic.

TP-40 Rainfall. Design storm rainfall depth data for various durations published by the National Weather Service in their Technical Paper 40 dated 1961.

Trained individual. An individual who is trained and experienced in the principles of storm water quality, including erosion and sediment control as may be demonstrated by state registration, professional certification (such as CESSWI and/or CPESC certification), or other documented and applicable experience or coursework as deemed sufficient by Franklin County that enable the individual to make judgments regarding storm water control or treatment and monitoring.

Transition Section. Reaches of the stream of floodway where water flows from a narrow cross-section to a wide cross-section or vice-versa.

Tributary. Based on the size of the contributing drainage area, a smaller watercourse which flows into a larger watercourse.

Turbidity. (1) Cloudiness of a liquid, caused by suspended solids. (2) A measure of the suspended solids in a liquid.

Underdrain. A small diameter perforated pipe that allows the bottom of a detention basin, channel or swale to drain.

Unified Soil Classification System. A system of classifying soils that is based on their identification according to particle size, gradation, plasticity index, and liquid limit.

Uniform Flow. A state of steady flow when the mean velocity and cross-sectional area remain constant in all sections of a reach.

Unit Hydrograph. A unit hydrograph is the hydrograph that results from one inch of precipitation excess generated uniformly over the watershed at a uniform rate during a specified period of time.

Urban Drain. A drain defined as "Urban Drain" in Indiana Drainage Code.

Urbanization. The development, change or improvement of any parcel of land consisting of one or more lots for residential, commercial, industrial, institutional, recreational or public utility purposes.

Vegetative practices. Any nonstructural or structural BMP that, with optimal design and good soil conditions, utilizes various forms of vegetation to enhance pollutant removal, maintain and improve natural site hydrology, promote healthier habitats, and increase aesthetic appeal. Examples include grass swales, filter strips, buffer strips, constructed wetlands, and rain gardens.

Vegetative Stabilization. Protection of erodible or sediment producing areas with: permanent seeding (producing long-term vegetative cover), short-term seeding (producing temporary vegetative cover), or sodding (producing areas covered with a turf of perennial sod-forming grass).

Water Course. Any river, stream, creek, brook, branch, natural or man-made drainage way in or into which stormwater runoff or floodwaters flow either regularly or intermittently.

Water Quality. A term used to describe the chemical, physical, and biological characteristics of water, usually in respect to its suitability for a particular purpose.

Water Resources. The supply of groundwater and surface water in a given area.

Water Table. (1) The free surface of the groundwater. (2) That surface subject to atmospheric pressure under the ground, generally rising and falling with the season or from other conditions such as water withdrawal.

Waterbody. Any accumulation of water, surface, or underground, natural or artificial.

Watercourse. Any river, stream, creek, brook, branch, natural or man-made drainageway in or into which stormwater runoff or floodwaters flow either continuously or intermittently.

Watershed Area. All land and water within the confines of a drainage divide. See also Watershed.

Watershed. The region drained by or contributing water to a specific point that could be along a stream, lake or other stormwater facilities. Watersheds are often broken down into subareas for the purpose of hydrologic modeling.

Waterway. A naturally existing or manmade open conduit or channel utilized for the conveyance of water.

Weir. A channel-spanning structure for measuring or regulating the flow of water.

Wellhead protection area. Has the meaning set forth at 327 IAC 8-4.1-1(27).

Wet-Bottom Detention Basin (Retention Basin) - A basin designed to retain a permanent pool of water after having provided its planned detention of runoff during a storm event.

Wetlands. Areas that are inundated or saturated by surface water or groundwater at a frequency and duration sufficient to support, and that under normal circumstances do support, a prevalence of vegetation typically adapted for life in saturated soil conditions.

APPENDIX B

APPLICATIONS, FORMS AND MISCELLANEOUS SHEETS REQUIRED TO COMPLY WITH THE *FRANKLIN COUNTY* STORMWATER MANAGEMENT ORDINANCE AND TECHNICAL STANDARDS

B1 –Stormwater Permit Forms

Application/Checklist for Stormwater Permit
Construction/SWPPP Technical Review Form
Petition to *Franklin County* Drainage Board
Statement of Financial Responsibility
BMP Maintenance Agreement
Project Check-In Checklist

B2 – Construction Inspection/Completion Forms

Construction Self-Monitoring Report
Certification of Completion & Compliance
Termination Inspection Checklist

B3 – Individual Lot/Parcel Permit Forms

Instructions for Individual Lot Permit Request
Individual Lot Permit Request Application
Individual Lot Typical Erosion & Sediment Control Plan and Certification
Plot Plan Review Form
Individual Lot Stormwater Pollution Prevention Requirements

B1 –Stormwater Permit Forms

Application/Checklist for Stormwater Permit
Construction/SWPPP Technical Review Form
Petition to *Franklin County* Drainage Board
Statement of Financial Responsibility
BMP Maintenance Agreement
Project Check-In Checklist

Non-MS4 communities who do not wish to proactively regulate the recommended stormwater quality measures, may delete Sections 5 and 6 of this application checklist.

| Franklin County Application/Checklist for Stormwater Permit (To Be Completed by Applicant) | | |
|--|---|---------------------|
| Project Name: | | |
| General Location: | | |
| Form Completed By (Name): | | Date Completed: |
| Total Site Acreage: | Proposed Land Disturbance Acreage: | |
| 1. Application Fee | | |
| Check Attached | | Amt. \$ |
| 2. Owner/Applicant Information | | |
| Owner Name: | Phone #: | E-Mail: |
| Engineer Company Name: | | |
| Engineer Name: | Phone #: | E-Mail: |
| Brief Project Purpose and Description: | | |
| 3. Construction Plans – General Requirements | | Page/Sheet # |
| 3.1 Title sheet which includes location map, vicinity map, operating authority, design company name, developer name, and index of plan sheets. | | |
| 3.2 A copy of a legal boundary survey for the site, performed in accordance with Rule 12 of Title 865 of the Indiana Administrative Code or any applicable and subsequently adopted rule or regulation for the subdivision limits, including all drainage easements and wetlands. | | |
| 3.3 A reduced plat or project site map showing the parcel identification numbers, the lot numbers, lot boundaries, easements, and road layout and names. The reduced map must be legible and submitted on a sheet or sheets no larger than eleven (11) inches by seventeen (17) inches for all phases or sections of the project site. | | |
| 3.4 | An existing project site layout that must include the following information: | |
| 3.4a | A topographic map of the land to be developed and such adjoining land whose topography may affect the layout or drainage of the development. The contour intervals shall be one (1) foot when slopes are less than or equal to two percent (<2%) and shall be two (2) feet when slopes exceed two percent (>2%). All elevations shall be given in either National Geodetic Vertical Datum of 1929 (NGVD) or North American Vertical Datum of 1988 (NAVD). The horizontal datum of topographic map shall be based on Indiana State Plane Coordinates, NAD83. The map will contain a notation indicating these datum information. <ul style="list-style-type: none"> i. If the project site is less than or equal to two (2) acres in total land area, the topographic map shall include all topography of land surrounding the site to a distance of at least one hundred (100) feet. | |

| | | | |
|---|--|--|---------------------|
| | ii. | If the project site is greater than two (2) acres in total land area, the topographic map shall include all topography of land surrounding the site to a distance of at least two hundred (200) feet. | |
| | 3.4b | Location, name, and normal water level of all wetlands, lakes, ponds, and water courses on or adjacent to the project site. | |
| | 3.4c | Location of storm, sanitary, combined sewer, and septic tank systems and outfalls. | |
| | 3.4d | The location of regulated drains, farm drains, inlets and outfalls, if any of record. | |
| | 3.4e | Location of all existing cornerstones within the proposed development and a plan to protect and preserve them. | |
| 3.5 | A grading and drainage plan, including the following information: | | |
| | 3.5a | Location of all proposed site improvements, including roads, utilities, lot delineation and identification, proposed structures, and common areas. | |
| | 3.5b | Delineation of all proposed land disturbing activities, including off-site activities that will provide services to the project site. | |
| | 3.5c | Information regarding any off-site borrow, stockpile, or disposal areas that are associated with a project site, regardless of who owns or controls those areas. Off-site disposal areas may need to have their own permits. | |
| | 3.5d | Location, size, and dimensions of all existing streams to be maintained, and new drainage systems such as culverts, bridges, storm sewers, conveyance channels, and 100-year overflow paths/ponding areas shown as hatched areas, along with the associated easements. | |
| | 3.5e | Location, size, and dimensions of features such as permanent retention or detention facilities, including existing or manmade wetlands, used for the purpose of stormwater management. Include existing retention or detention facilities that will be maintained, enlarged, or otherwise altered and new ponds or basins to be built. | |
| | 3.5f | One or more typical cross sections of all existing and proposed channels or other open drainage facilities carried to a point above the 100-year high water and showing the elevation of the existing land and the proposed changes, together with the high water elevations expected from the 100 year storm under the controlled conditions called for by this ordinance, and the relationship of structures, streets, and other facilities. | |
| 3.6 | Utility plan sheet(s) showing the location of all proposed utility lines for the project | | |
| 3.7 | Storm sewer plan/profile sheet(s) showing the elevation, size, length, location of all proposed storm sewers. Existing and proposed ground grades, storm sewer structures elevations, and utility crossings also must be included. | | |
| 3.8 | A 24-inch by 36-inch plat, including the following information: | | |
| | 3.8a | Legal description. | |
| | 3.8b | Cross reference to Rule 12. | |
| | 3.8c | Regulated drain statement and table. | |
| 3.9 | Any other information required by <i>Franklin County</i> to thoroughly evaluate the submitted material. | | |
| 4. Storm Water Drainage Technical Report | | | Page/Sheet # |
| 4.1 | A summary report, including the following information: | | |
| | 4.1a | Description of the nature and purpose of the project. | |
| | 4.1b | The significant drainage problems associated with the project. | |
| | 4.1c | The analysis procedure used to evaluate these problems and to propose solutions. | |
| | 4.1d | Any assumptions or special conditions associated with the use of these procedures, especially the hydrologic or hydraulic methods. | |

| | | | |
|---|--|--|---------------------|
| | 4.1e | The proposed design of the drainage control system. | |
| | 4.1f | The results of the analysis of the proposed drainage control system showing that it does solve the project's drainage problems. Any hydrologic or hydraulic calculations or modeling results must be adequately cited and described in the summary description. If hydrologic or hydraulic models are used, the input and output files for all necessary runs must be included in the appendices. A map showing any drainage area subdivisions used in the analysis must accompany the report. | |
| | 4.1g | Proof of Errors and Omissions Insurance for the registered professional engineer or licensed surveyor showing a minimum amount of \$1,000,000 in coverage. | |
| 4.2 | A Hydrologic/Hydraulic Analysis, consistent with the methodologies and calculation included in the technical standards, and including the following information: | | |
| | 4.2a | A hydraulic report detailing existing and proposed drainage patterns on the subject site. The report should include a description of present land use and proposed land use. Any off-site drainage entering the site should be addressed as well. This report should be comprehensive and detail all of the steps the engineer took during the design process. | |
| | 4.2b | All hydrologic and hydraulic computations should be included in the submittal. These calculations should include, but are not limited to: runoff curve numbers and runoff coefficients, runoff calculations, stage-discharge relationships, times-of-concentration and storage volumes. | |
| | 4.2c | Copies of all computer runs. These computer runs should include both the input and the outputs. Electronic copies of the computer runs with input files will expedite the review process and is required to be submitted. | |
| | 4.2d | A set of exhibits should be included showing the drainage sub-areas and a schematic detailing of how the computer models were set up. | |
| | 4.2e | A conclusion which summarizes the hydraulic design and details how this design satisfies this Ordinance. | |
| 5. Stormwater Pollution Prevention Plan for Construction Sites | | | Page/Sheet # |
| 5.1 | Construction Plan Elements (Section A in IDEM Form) | | |
| | A1 | Index of the location of required plan elements in the construction plan | |
| | A2 | A vicinity map depicting the project site location in relationship to recognizable local landmarks, towns, and major roads | |
| | A3 | Narrative of the nature and purpose of the project | |
| | A4 | Latitude and longitude to the nearest fifteen (15) seconds | |
| | A5 | Legal description of the project site | |
| | A6 | 11 X 17-inch plat showing building lot numbers/boundaries and road layout/names | |
| | A7 | Boundaries of the one hundred (100) year floodplains, floodway fringes, and floodways | |
| | A8 | Land use of all adjacent properties | |
| | A9 | Identification of a U.S. EPA approved or established TMDL | |
| | A10 | Name(s) of the receiving water(s) | |

| | | | |
|-----|---|---|--|
| | A11 | Identification of discharges to a water on the current 303d list of impaired waters and the pollutant(s) for which it is impaired | |
| | A12 | Soil map of the predominant soil types | |
| | A13 | Identification and location of all known wetlands, lakes and water courses on or adjacent to the project site (construction plan, existing site layout) | |
| | A14 | Identification of any other state or federal water quality permits or authorizations that are required for construction activities | |
| | A15 | Identification and delineation of existing cover, including natural buffers | |
| | A16 | Existing topography at a contour interval appropriate to indicate drainage patterns | |
| | A17 | Location(s) of where run-off enters the project site | |
| | A18 | Location(s) of where run-off discharges from the project site prior to land disturbance | |
| | A19 | Location of all existing structures on the project site | |
| | A20 | Existing permanent retention or detention facilities, including manmade wetlands, designed for the purpose of stormwater management | |
| | A21 | Locations where stormwater may be directly discharged into ground water, such as abandoned wells, sinkholes, or karst features | |
| | A22 | Size of the project area expressed in acres | |
| | A23 | Total expected land disturbance expressed in acres | |
| | A24 | Proposed final topography | |
| | A25 | Locations and approximate boundaries of all disturbed areas | |
| | A26 | Location, size, and dimensions of all stormwater drainage systems, such as culverts, storm sewers, and conveyance channels | |
| | A27 | Locations of specific points where stormwater and non-stormwater discharges will leave the project site | |
| | A28 | Location of all proposed site improvements, including roads, utilities, lot delineation and identification, proposed structures, and common areas | |
| | A29 | Location of all on-site soil stockpiles and borrow areas | |
| | A30 | Construction support activities that are expected to be part of the project | |
| | A31 | Location of any in-stream activities that are planned for the project including, but not limited to stream crossings and pump arounds | |
| 5.2 | Erosion and Sediment Control/Project Site Management (Section B in IDEM Form) | | |
| | B1 | Description of the potential pollutant generating sources and pollutants, including all potential non-stormwater discharges | |
| | Where applicable, Items in B2 through B10 below will be evaluated for location, dimensions, detailed specifications, and construction details | | |
| | B2 | Stable construction entrance locations and specifications | |
| | B3 | Specifications for temporary and permanent stabilization | |

| | | | |
|---|--|---|---------------------|
| | B4 | Sediment control measures for concentrated flow areas | |
| | B5 | Sediment control measures for sheet flow areas | |
| | B6 | Run-off control measures | |
| | B7 | Stormwater outlet protection locations and specifications | |
| | B8 | Grade stabilization structure locations and specifications | |
| | B9 | Dewatering applications and management methods | |
| | B10 | Measures utilized for work within waterbodies | |
| | B11 | Maintenance guidelines for each proposed temporary stormwater quality measure | |
| | B12 | Planned construction sequence describing the relationship between implementation of stormwater quality measures in relation to land disturbance | |
| | B13 | Provisions for erosion and sediment control on individual building lots regulated under the proposed project | |
| | B14 | Material handling, spill prevention and spill response plan meeting requirements in 327 IAC 2-6.1 | |
| | B15 | Material handling and storage procedures associated with construction activity | |
| 6. Post-Construction Stormwater Pollution Prevention Plan | | | Page/Sheet # |
| 6.1 | SWPPP – Post-Construction (Section C in IDEM Form) | | |
| | C1 | Description of pollutants and their sources associated with the proposed land use | |
| | C2 | Description of proposed post-construction stormwater measures | |
| | C3 | Plan details for each stormwater measure | |
| | C4 | Sequence describing stormwater measure implementation | |
| | C5 | Maintenance guidelines for proposed post-construction stormwater measures | |
| | C6 | Entity that will be responsible for operation and maintenance of the post-construction stormwater measures | |
| 7. Project Check-in Checklist | | | Page/Sheet # |
| Must be completed and all items listed must be provided at project submittal. | | | |

| | |
|---------------------------------|--|
| <i>Franklin County, Indiana</i> | Construction/ Stormwater Pollution Prevention Plan Technical Review Franklin County Stormwater Technical Standards IDEM Construction Stormwater General Permit: https://www.in.gov/idem/stormwater/construction-land-disturbance-permitting/ (INRA00000 effective 12/18/2021) |
|---------------------------------|--|

Construction/Stormwater Pollution Prevention Plan Technical Review and Comment

| | |
|---|---|
| Project Name: Scope of Project: County(ies): Latitude: Longitude: | Plan Submittal Date: Click here to enter a date. Plan Review Date: Click here to enter a date. |
|---|---|

| | |
|-----------------------|--|
| Plan Preparer: | Affiliation: |
| Address: | |
| City: | State: Zip: |
| Phone: | Cell Phone: Email: |

| |
|--|
| |
|--|

| | |
|----------------------------|--|
| Project Site Owner: | Company Name (if applicable): |
| Address: | |
| City: | State: Zip: |
| Phone: | Cell Phone: Email: |

| | | |
|-----------------------|--|----------------------|
| Plan Reviewer: | Affiliation: | On behalf of: |
| Address: | | |
| City: | State: Zip: | |
| Phone: | Cell Phone: Email: | |

Plan Review Status:

| | | |
|--------------------------|-------------------------------|--|
| <input type="checkbox"/> | Plan is Adequate | A comprehensive plan review has been completed and it has been determined that the plan satisfies the minimum requirements of the <i>Franklin County</i> Stormwater Ordinance and Technical Standards and the Construction Stormwater General Permit INRA00000 (Effective 12-18-2021). |
| <input type="checkbox"/> | Preliminary Review | A comprehensive review will not be completed at this time. The plan review authority reserves the right to perform a comprehensive review at a later date, and revisions may be required at that time. |
| <input type="checkbox"/> | Conditional Acceptance | Acceptance of the plan is conditional. The conditional acceptance is contingent upon addressing the issues identified in the comment sections. |

| | | |
|--------------------------|---|--|
| <input type="checkbox"/> | Plan is Deficient | Significant deficiencies were identified and must be addressed. Refer to the comment sections. |
| Action: | | |
| <input type="checkbox"/> | Submit a Notice of Intent: | <ul style="list-style-type: none"> Submit the Notice of Intent (NOI) online through the IDEM Regulatory ePortal. It is required to upload a copy of this review form when submitting the NOI through the IDEM Regulatory ePortal: (https://stormwater.idem.in.gov/ncore/external/home) |
| <input type="checkbox"/> | Do not file a Notice of Intent or commence land-disturbing activities: | Deficiencies must be adequately addressed and an acceptable plan review completed. |
| <input type="checkbox"/> | Comments: | Refer to Plan Review Comments Sections of this document. |
| <input type="checkbox"/> | Revisions: | Update and submit the revised Construction/Stormwater Pollution Prevention Plan as indicated below. |
| | <input type="checkbox"/> | Update and submit a complete plan set that addresses plan deficiencies. |
| | <input type="checkbox"/> | Update and submit a document (narrative and/or plan sheets) that address plan deficiencies. |
| | <input type="checkbox"/> | Update and submit a complete plan set that addresses plan deficiencies. A comprehensive plan review will not be completed. |

| | |
|---|--|
| Plan Review Information | |
| <ul style="list-style-type: none"> <i>The technical review and comment is intended to evaluate the completeness of the Construction/Stormwater Pollution Prevention Plan for the project. The Plan submitted was not reviewed for the adequacy of engineering design. All measures included in the plan, as well as those recommended in the comments should be evaluated as to their feasibility by a qualified individual with structural measures designed by a qualified engineer. The Plan has not been reviewed for other local, state, or federal permits that may be required to proceed with this project.</i> <i>Additional information, including design calculations may be requested to further evaluate the plan.</i> <i>All proposed stormwater pollution prevention measures and those referenced in this review must meet the design criteria and standards set forth in the "Indiana Stormwater Quality Manual" from the Indiana Department of Environmental Management or similar Guidance Documents.</i> <i>Construction activities and unforeseen weather conditions may affect the performance of the erosion and sediment control system, individual measures, or the effectiveness of the plan. The plan must be a flexible document, with provisions to modify or substitute measures as necessary to ensure compliance.</i> | |
| Section A: Construction Plan Elements | |

| Adequate | Deficient | NA | A | <i>The construction plan elements include general information associated with the project site that are critical for the evaluation of the stormwater pollution prevention plan component. This information includes, but is not limited to an index, resource information, reference maps, grading information, project layout and design, and drainage plan</i> |
|--------------------------|--------------------------|--------------------------|-----------|---|
| <input type="checkbox"/> | <input type="checkbox"/> | <input type="checkbox"/> | 1 | Index of the location of required plan elements in the construction plan |
| <input type="checkbox"/> | <input type="checkbox"/> | <input type="checkbox"/> | 2 | A vicinity map depicting the project site location in relationship to recognizable local landmarks, towns, and major roads |
| <input type="checkbox"/> | <input type="checkbox"/> | <input type="checkbox"/> | 3 | Narrative of the nature and purpose of the project |
| <input type="checkbox"/> | <input type="checkbox"/> | <input type="checkbox"/> | 4 | Latitude and longitude to the nearest fifteen (15) seconds |
| <input type="checkbox"/> | <input type="checkbox"/> | <input type="checkbox"/> | 5 | Legal description of the project site |
| <input type="checkbox"/> | <input type="checkbox"/> | <input type="checkbox"/> | 6 | 11 X 17-inch plat showing building lot numbers/boundaries and road layout/names |
| <input type="checkbox"/> | <input type="checkbox"/> | <input type="checkbox"/> | 7 | Boundaries of the one hundred (100) year floodplains, floodway fringes, and floodways |
| <input type="checkbox"/> | <input type="checkbox"/> | <input type="checkbox"/> | 8 | Land use of all adjacent properties |
| <input type="checkbox"/> | <input type="checkbox"/> | <input type="checkbox"/> | 9 | Identification of a U.S. EPA approved or established TMDL |
| <input type="checkbox"/> | <input type="checkbox"/> | <input type="checkbox"/> | 10 | Name(s) of the receiving water(s) |
| <input type="checkbox"/> | <input type="checkbox"/> | <input type="checkbox"/> | 11 | Identification of discharges to a water on the current 303d list of impaired waters and the pollutant(s) for which it is impaired |
| <input type="checkbox"/> | <input type="checkbox"/> | <input type="checkbox"/> | 12 | Soil map of the predominant soil types |
| <input type="checkbox"/> | <input type="checkbox"/> | <input type="checkbox"/> | 13 | Identification and location of all known wetlands, lakes and water courses on or adjacent to the project site (construction plan, existing site layout) |
| <input type="checkbox"/> | <input type="checkbox"/> | <input type="checkbox"/> | 14 | Identification of any other state or federal water quality permits or authorizations that are required for construction activities |
| <input type="checkbox"/> | <input type="checkbox"/> | <input type="checkbox"/> | 15 | Identification and delineation of existing cover, including natural buffers |
| <input type="checkbox"/> | <input type="checkbox"/> | <input type="checkbox"/> | 16 | Existing topography at a contour interval appropriate to indicate drainage patterns |
| <input type="checkbox"/> | <input type="checkbox"/> | <input type="checkbox"/> | 17 | Location(s) of where run-off enters the project site |
| <input type="checkbox"/> | <input type="checkbox"/> | <input type="checkbox"/> | 18 | Location(s) of where run-off discharges from the project site prior to land disturbance |
| <input type="checkbox"/> | <input type="checkbox"/> | <input type="checkbox"/> | 19 | Location of all existing structures on the project site |
| <input type="checkbox"/> | <input type="checkbox"/> | <input type="checkbox"/> | 20 | Existing permanent retention or detention facilities, including manmade wetlands, designed for the purpose of stormwater management |
| <input type="checkbox"/> | <input type="checkbox"/> | <input type="checkbox"/> | 21 | Locations where stormwater may be directly discharged into ground water, such as abandoned wells, sinkholes, or karst features |
| <input type="checkbox"/> | <input type="checkbox"/> | <input type="checkbox"/> | 22 | Size of the project area expressed in acres |

| Adequate | Deficient | NA | A | |
|--|--------------------------|--------------------------|----|---|
| | | | | <i>The construction plan elements include general information associated with the project site that are critical for the evaluation of the stormwater pollution prevention plan component. This information includes, but is not limited to an index, resource information, reference maps, grading information, project layout and design, and drainage plan</i> |
| <input type="checkbox"/> | <input type="checkbox"/> | <input type="checkbox"/> | 23 | Total expected land disturbance expressed in acres |
| <input type="checkbox"/> | <input type="checkbox"/> | <input type="checkbox"/> | 24 | Proposed final topography |
| <input type="checkbox"/> | <input type="checkbox"/> | <input type="checkbox"/> | 25 | Locations and approximate boundaries of all disturbed areas |
| <input type="checkbox"/> | <input type="checkbox"/> | <input type="checkbox"/> | 26 | Location, size, and dimensions of all stormwater drainage systems, such as culverts, storm sewers, and conveyance channels |
| <input type="checkbox"/> | <input type="checkbox"/> | <input type="checkbox"/> | 27 | Locations of specific points where stormwater and non-stormwater discharges will leave the project site |
| <input type="checkbox"/> | <input type="checkbox"/> | <input type="checkbox"/> | 28 | Location of all proposed site improvements, including roads, utilities, lot delineation and identification, proposed structures, and common areas |
| <input type="checkbox"/> | <input type="checkbox"/> | <input type="checkbox"/> | 29 | Location of all on-site soil stockpiles and borrow areas |
| <input type="checkbox"/> | <input type="checkbox"/> | <input type="checkbox"/> | 30 | Construction support activities that are expected to be part of the project |
| <input type="checkbox"/> | <input type="checkbox"/> | <input type="checkbox"/> | 31 | Location of any in-stream activities that are planned for the project including, but not limited to stream crossings and pump arounds |
| Section A – Comments: | | | | |
| <ul style="list-style-type: none"> Evaluate areas with potential waters of the state and, where required, verify if permits/authorizations are required prior to any impacts to waters of the state. These potential resources include areas with hydric soil, hydrophytic vegetation, pooling water, or evidence of flowing water such as swales, ditches, drains, or natural conveyances. Evaluation of hydric soil, hydrophytic vegetation, or pooling water should conform to the US Army Corps of Engineers Wetlands Delineation Manual," Technical Report Y-87-1, and the applicable regional supplement https://www.usace.army.mil/Missions/Civil-Works/Regulatory-Program-and-Permits/reg_supp/. Avoidance and minimization of impacts to waters of the state should be prioritized. | | | | |

Section B: Stormwater Pollution Prevention Plan – Erosion and Sediment Control/Project Site Management

| Adequate | Deficient | NA | B | <i>The construction component of the Stormwater Pollution Prevention Plan includes stormwater quality measures to address erosion, sedimentation, and other pollutants associated with land disturbance and construction activities. Proper implementation of the plan, maintenance of measures, and administering a self-monitoring program is required to manage the project site to minimize the discharge of sediment and other pollutants. Construction activities and unforeseen weather conditions may affect the performance of the erosion and sediment control system, individual measures, or the effectiveness of the plan. The plan must be a flexible document, with provisions to modify or substitute measures as necessary to ensure compliance.</i> |
|----------|-----------|----|----------|---|
|----------|-----------|----|----------|---|

| | | | | |
|--------------------------|--------------------------|--------------------------|----------|---|
| <input type="checkbox"/> | <input type="checkbox"/> | <input type="checkbox"/> | 1 | Description of the potential pollutant generating sources and pollutants, including all potential non-stormwater discharges |
|--------------------------|--------------------------|--------------------------|----------|---|

Where applicable, Items in 2 through 10 below will be evaluated for Location, dimensions, detailed specifications, and construction details

| | | | | |
|--------------------------|--------------------------|--------------------------|-----------|---|
| <input type="checkbox"/> | <input type="checkbox"/> | <input type="checkbox"/> | 2 | Stable construction entrance locations and specifications |
| <input type="checkbox"/> | <input type="checkbox"/> | <input type="checkbox"/> | 3 | Specifications for temporary and permanent stabilization |
| <input type="checkbox"/> | <input type="checkbox"/> | <input type="checkbox"/> | 4 | Sediment control measures for concentrated flow areas |
| <input type="checkbox"/> | <input type="checkbox"/> | <input type="checkbox"/> | 5 | Sediment control measures for sheet flow areas |
| <input type="checkbox"/> | <input type="checkbox"/> | <input type="checkbox"/> | 6 | Run-off control measures |
| <input type="checkbox"/> | <input type="checkbox"/> | <input type="checkbox"/> | 7 | Stormwater outlet protection locations and specifications |
| <input type="checkbox"/> | <input type="checkbox"/> | <input type="checkbox"/> | 8 | Grade stabilization structure locations and specifications |
| <input type="checkbox"/> | <input type="checkbox"/> | <input type="checkbox"/> | 9 | Dewatering applications and management methods |
| <input type="checkbox"/> | <input type="checkbox"/> | <input type="checkbox"/> | 10 | Measures utilized for work within waterbodies |
| <input type="checkbox"/> | <input type="checkbox"/> | <input type="checkbox"/> | 11 | Maintenance guidelines for each proposed temporary stormwater quality measure |
| <input type="checkbox"/> | <input type="checkbox"/> | <input type="checkbox"/> | 12 | Planned construction sequence describing the relationship between implementation of stormwater quality measures in relation to land disturbance |
| <input type="checkbox"/> | <input type="checkbox"/> | <input type="checkbox"/> | 13 | Provisions for erosion and sediment control on individual building lots regulated under the proposed project |
| <input type="checkbox"/> | <input type="checkbox"/> | <input type="checkbox"/> | 14 | Material handling and spill prevention and spill response plan meeting the requirements in 327 IAC 2-6.1 |
| <input type="checkbox"/> | <input type="checkbox"/> | <input type="checkbox"/> | 15 | Material handling and storage procedures associated with construction activity |

Section B – Comments:

- Stormwater quality measures for the reduction of sediment have not been evaluated for adequacy of design. The proposed measures included in this SWPPP are being accepted based on the design engineer’s submittal.

Section C: Stormwater Pollution Prevention Plan – Post-Construction

| Adequate | Deficient | NA | C | |
|--|--------------------------|--------------------------|---|--|
| <i>The post-construction component of the Stormwater Pollution Prevention Plan includes the implementation of stormwater quality measures to address pollutants that will be associated with the final project land use. Post-construction stormwater measures should be functional upon completion of the project. Long term functionality of the measures is critical to their performance and should be monitored and maintained.</i> | | | | |
| <input type="checkbox"/> | <input type="checkbox"/> | <input type="checkbox"/> | 1 | Description of pollutants and their sources associated with the proposed land use |
| <input type="checkbox"/> | <input type="checkbox"/> | <input type="checkbox"/> | 2 | Description of proposed post-construction stormwater measures |
| <input type="checkbox"/> | <input type="checkbox"/> | <input type="checkbox"/> | 3 | Plan details for each stormwater measure |
| <input type="checkbox"/> | <input type="checkbox"/> | <input type="checkbox"/> | 4 | Sequence describing stormwater measure implementation |
| <input type="checkbox"/> | <input type="checkbox"/> | <input type="checkbox"/> | 5 | Maintenance guidelines for proposed post-construction stormwater measures |
| <input type="checkbox"/> | <input type="checkbox"/> | <input type="checkbox"/> | 6 | Entity that will be responsible for operation and maintenance of the post-construction stormwater measures |

Section C – Comments:

- Post-construction stormwater quality and quantity measures have not been evaluated for adequacy of design. The proposed measures included in this SWPPP are being accepted based on the design engineer’s submittal.
- The rate of stormwater run-off and/or volume from the project site must meet local requirements to address stormwater quantity as established by ordinance or other regulatory mechanism. When a local requirement does not exist, the post-development run-off discharge from the project site must not exceed the pre-development discharge based on the two-year, ten-year, and one-hundred-year peak storm events.

Statement of Financial Responsibility

The undersigned of the proposed project to be known as

do hereby agree to take full responsibility of financial payment of review fees incurred on the above project. I am aware that the review fees will begin as soon as primary and/or secondary application is filed and continues until the project is approved and/or withdrawn. I understand that if the project is withdrawn the review fees are still due and payable from the application date to the date on the letter of withdrawal. No project will receive an approval letter nor will the plat be approved for recording until all fees are paid. All review fees are made payable to Franklin County.

The undersigned, having duly sworn upon oath, that the above information has been read and fully understood to be true and correct and is (undersigned) voluntary act and deed. The undersigned assumes responsibility for the aforementioned fees.

Signature

Mailing Address

Signature Printed

City, State, Zip Code

STATE OF INDIANA)
)
COUNTY OF _____)

Subscribed and sworn before me, a Notary Public, within and for said County and State, this _____ day of _____, 20_____.

My Commission Expires _____

Notary Public _____

(Notary Stamp or Seal)

Project Check-In Checklist

Project Name: _____

Engineer: _____ Contact Person: _____

Address: _____

Phone Number: _____ Fax Number: _____

Developer/Owner: _____ Contact Person: _____

Address: _____

Phone Number: _____ Fax Number: _____

Project Information:

Section: _____ Township: _____ Range: _____

Township: _____ City: _____

Number of Lots: _____ Acres: _____

Parcel Number: _____ Reg. Drain: _____

Accepted Drainage Footage:

Open: _____ Tile: _____

Checklist:

1 Copy of Petition Signed & Notarized by Owner: _____

1 Copy of Legal Description: _____ 2 Sets of Plans: _____

1 Copy of Engineer Statement: _____ 1 CD (with complete project submittal): _____

1 Copy of application checklist: _____ 1 Check for Application Fee: _____

1 Copy of Regulated Drain Exhibit (if applicable): _____

1 Copy of Stormwater Drainage Technical Report: _____

Original Letter and 1 copy of Financial Responsibility: _____

1 Copy of Project Check-In Checklist (this sheet): _____

OFFICE USE ONLY

Assessment: _____

Revisions: _____

Approval: _____

Denial: _____

B3 - Individual Lot/Parcel Permit Forms

Instructions for Individual Lot Permit Request
Individual Lot Permit Request Application
Typical Erosion & Sediment Control Plan and Certification
Plot Plan Review Form
Individual Lot Stormwater Pollution Prevention Requirements

INSTRUCTIONS FOR INDIVIDUAL LOT PERMIT REQUEST

1. Request shall be made to Franklin County.
2. Request shall be made on standard form only, supplied by Franklin County.
3. The form shall be completely filled out, including the following information:
 - a. Name of subdivision/minor plat and lot number.
 - b. Section/Township/Range
 - c. Parcel number of property involved.
 - d. Project name (if none then put individual's name).
 - e. Contact person(s).
 - f. Type of residential lot and/or improvement. This office may require more details depending on the type of improvements being proposed.
4. A certified Plot Plan, including site layout is required to be submitted with each permit application.
5. An erosion and sediment control plan is required to be submitted with each permit application.
6. Applicant will need to provide the name, address telephone number, and list of qualifications of the trained individual in charge of the mandatory stormwater pollution prevention self-monitoring program for the project site.
7. Applicant will need to abide by any additional requirements set forth in the *Franklin County Stormwater Management Ordinance* and/or Technical Standards.
8. The applicant or an agent of the applicant must sign the form.
9. Check or money order is to be made payable to Franklin County. The correct amount of fee, based on the Fee Ordinance, must be included with the application package.

INDIVIDUAL LOT PERMIT REQUEST

Name of Subdivision/Minor Plat & Lot #: _____ Project Name: _____
Parcel Number: _____ Section/Township/Range _____
Township Name: _____

Applicant's Name: _____ Property Owner: _____
Address: _____ Property Address: _____
Phone: (____) _____ Phone: (____) _____
Fax: (____) _____ Fax: (____) _____

Contractor/Builder: _____
Address: _____
Phone: (____) _____ Fax: (____) _____
Contact Person: _____ Cell Phone: _____

Type of Residential Lot or Improvement: _____

Trained Individual in Charge of the Mandatory Stormwater Pollution Prevention Program Name: _____
Address: _____ Phone #: _____
List of Qualifications): _____









The individual lot operator is responsible for installation and maintenance of all erosion and sediment control measures until the site is stabilized.

Date _____ Signature _____

Check Title: Owner _____ Contractor _____ Engineer _____ Agent _____ Other _____

| |
|---|
| *** For Office Use Only *** Engineering Firm: _____ Permit # _____ Plan Project # _____ Check # _____ |
|---|

Legend and Check List

| | | |
|---|---------------------------------|--------------------------|
|  | Silt Fence | <input type="checkbox"/> |
|  | Gravel Construction Entrance | <input type="checkbox"/> |
|  | Drop Inlet Protection | <input type="checkbox"/> |
|  | Curb Inlet Protection | <input type="checkbox"/> |
|  | Temporary Seeding | <input type="checkbox"/> |
|  | Property Lines / Drainage Swale | <input type="checkbox"/> |
|  | Constructed Building Pad | <input type="checkbox"/> |
|  | Soil Stockpile Protection | <input type="checkbox"/> |

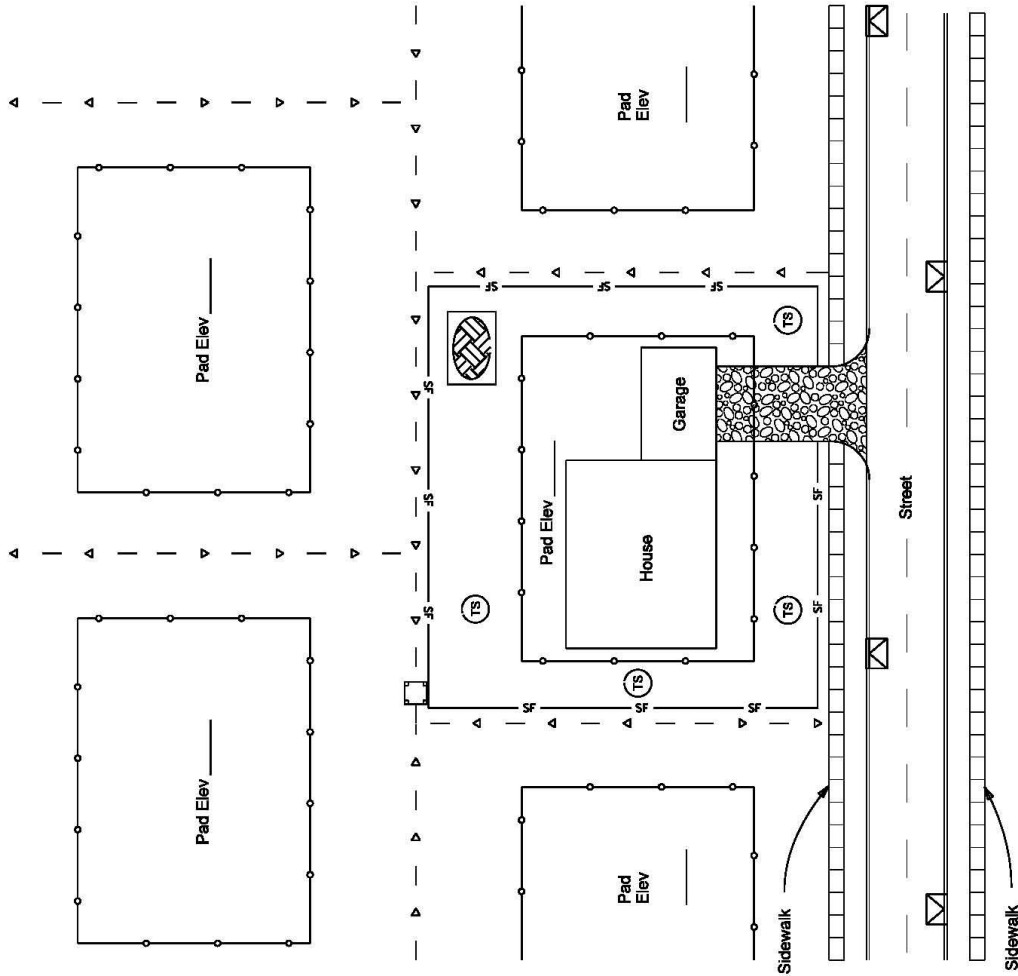

Notes:

- Draw in any "Do Not Disturb" areas.
- Provide pad elevations for subject property and adjacent properties.
- Erosion Control Measures must be functional and maintained throughout construction.

I hereby certify that the drainage ways, pad elevations, and erosion and sediment control measures are consistent with the overall development plans.

Signature _____ Date _____

Individual Lot Erosion and Sediment Control Plan and Certification

Plot Plan Review

Landowner _____ Parcel # _____
Legal Description _____ Erosion Fee _____

- Legal Description
- Stamped by Engineer/Surveyor _____
- "N" arrow and scale
- Site/location map
- Flood Zone _____ Map # _____
- Check for Wetland
- Dimension of Lot
 - House finish floor 2' above road elevation
 - House finish floor in relationship to pond normal pool
 - Driveway location not over curb inlets or storm sewers
 - Show utilities
 - Water
 - Sanitary
 - Septic with perimeter tile location & outlet with elevations
 - 8" tile, storm piping, or regulated drain
 - Swales
 - Elevations-centerline of road
 - Inlet/outlet elevations
 - Benchmark
 - Easements
 - Field verified elevations
- Erosion Control
 - * Temporary Driveway or construction entrance
 - * Lot Stabilization – silt fence or equivalent
 - * Curb or Yard inlet stabilization
 - * Pond protection
 - * Street protection
 - * Seeding-permanent, temporary (timeline)
 - * Undisturbed area marked
 - * Stockpile area marked and protected

*Endangered species area

* Responsible Individual _____

Additional Comments: _____

Reviewed By: _____ Date Received: _____
Date Reviewed: _____ Revisions: _____ Approval Number: _____
Date Approved: _____ Date Taken to Planning: _____
Called: _____ Faxed Comments: _____

Individual Lot/Parcel Stormwater Pollution Prevention Requirements

FOR COMPLIANCE WITH *FRANKLIN COUNTY* STORMWATER CODE

THE INDIVIDUAL LOT OWNER OR OPERATOR IS RESPONSIBLE FOR THE INSTALLATION AND MAINTENANCE OF STORMWATER POLLUTION PREVENTION CONTROLS UNTIL THE ENTIRE LOT IS COMPLETE AND 100% STABILIZED.

- Initial Stormwater controls such as construction entrances, curbside and rear of lot storm inlet protection (geo-textile wrapped under grate is prohibited), and perimeter controls (typically silt fence) must be in place BEFORE ANY LOT DISTURBANCE begins.
- All construction materials must be staged off of the street and on the lot behind perimeter controls.
- Portable toilets must be kept off of the street and should be placed on even ground on the lot behind perimeter controls.
- All lots must provide and utilize appropriate trash containment for site waste.
- Contractors must use appropriate practices for concrete, mortar, and paint washout. These materials must be properly contained and NOT enter the storm drains or other conveyances.
- Any off site tracking of sediment into the street, or off site sedimentation into swales or drains MUST be cleaned as soon as possible and by no later than the end of the day.
- Lot frontage should be cleaned and acceptable in appearance at the end of every business day.
- Areas where operations have impacted adjacent lots or rear yard swales MUST be repaired to design condition and 100% stabilized.

PLEASE NOTE: ANY INSPECTION WILL FAIL IF THE CORRECT STORMWATER POLLUTION PREVENTION CONTROLS ARE NOT IN PLACE AND PROPERLY MAINTAINED.

Stormwater Pollution Prevention Controls on Individual Lots

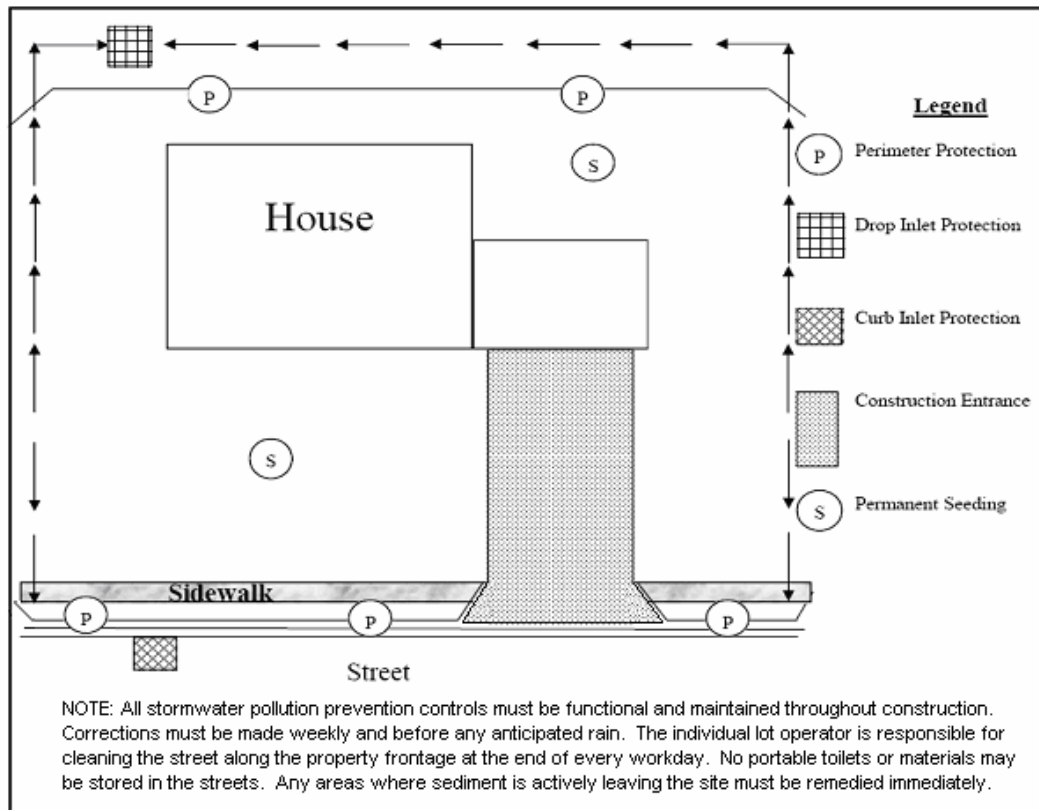

Construction Sequence

1. Install construction entrance.
 - a. Use #2 stone. Flare entrance at street so it can handle vehicle turn radius. See Detail.
2. Install perimeter protection.
 - a. Protection along the sides of the lot is only necessary if the adjacent lot is built out or if stormwater runoff will drain in that direction.
 - b. Make sure perimeter protections are turned into the lot where they terminate to create a ponding area. See above diagram.
 - c. Rear of lot perimeter protection should be installed to protect the rear yard swale.
3. Install protections on storm inlets at curbside and at rear of lot.
 - a. Geo-textile or "fabric" wrapped underneath the grate is **PROHIBITED**.
 - b. Make sure curbside inlet protection leaves the top 3-4 inches of the storm grate exposed to allow for overflow to enter the storm inlet, preventing ponding.
4. Lot disturbance may begin once the controls listed above are in place.
5. Maintain lot controls at all times and repair as soon as possible when a correction is needed.
 - a. If sediment is actively leaving the site due to a failing control such as tracking or an operation such as dewatering, it must be corrected **IMMEDIATELY**.
6. Stabilize all exposed soils with vegetation, mulch, or stone when construction is complete.
 - a. Lot is considered stabilized once vegetation has reached 100% coverage and 70 % density.
7. Remove temporary stormwater pollution prevention controls.

- a. These may be removed when exposed soils have been stabilized with vegetation, sod, or mulch.
- b. Seed alone is not a stabilization measure until it germinates and achieves proper coverage.

BMP DETAILS

Silt Fence

1. Install silt fence parallel to the contour of the land.
2. Extend ends of silt fence upslope 3-4 feet to allow for ponding areas behind the fence.
3. Excavate trench 8 inches deep and 4 inches wide.
4. Install with stakes on the down slope side of fence.
5. Bury 12 inches of fabric in the trench, extending the bottom 4 inches toward the upslope side.
6. Backfill trench on both sides of fence and compact.
7. Join silt fence sections by wrapping two posts and driving them in together. Do not use any other method of joining.

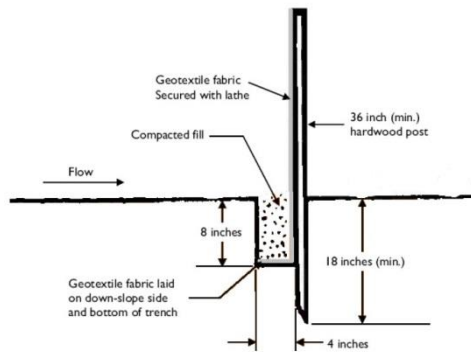

8. Inspect weekly and within 24 hrs of a ½" of rain. Silt fence should be cleaned out when the sediment has reached 1/3 the height of the exposed fencing. Repair silt fence where torn or damaged. Complete repairs before the next anticipated rain and by no later than one week from the date they are noticed.

Construction Entrance

1. Install construction entrance from street to face of proposed building or at a 50' minimum length. Use #2 stone at a 6" minimum depth.
2. A geo-textile is required underneath the entrance to extend its functionality.
3. Flare out entrance where it meets the street so that vehicle turn radiuses do not travel over disturbed ground.

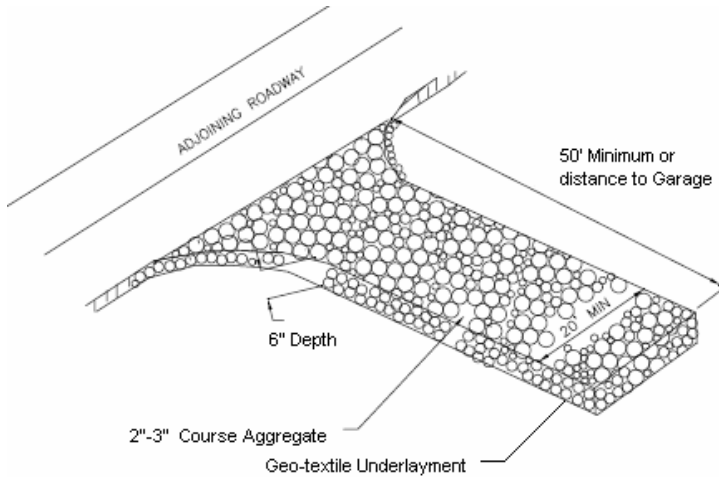

4. Perimeter Controls (silt fence) should be turned into the lot for a few feet where they meet the construction entrance.
5. Inspect weekly and within 24 hrs of a ½" of rain. Freshen or replace stone as needed to prevent off site tracking. If offsite tracking is occurring, clean up immediately, and correct the reason why the drive is failing as soon as possible. Complete repairs before the next anticipated rain and by no later than one week from the date they are noted.

Inlet Protection

1. Install inlet protection on all curbside and rear of lot storm
2. Curbside inlet protection should be installed so that 3 – 4 inches of the top of the casting is exposed to allow for overflow, preventing excessive ponding.
3. Wrapping geo-textile underneath the grate for protection or straw bale barriers are **PROHIBITED** practices.
4. Make sure inlet protection is securely fastened to the storm grate and installed per the manufacturer's recommendations.

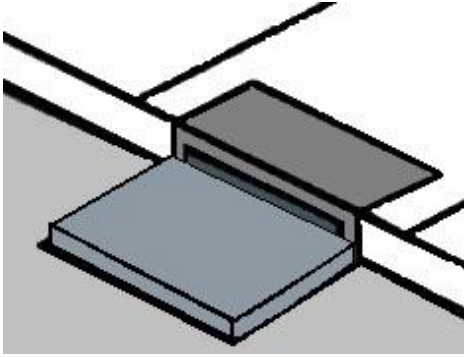

5. Inspect weekly and within 24 hours of a ½” of rain. Sediment accumulation or standing water around the inlet can indicate the need for maintenance. Clean protection when clogged with sediment or when it reaches ½ of the storage capacity or height of the control. Replace protection if torn or worn. Clean sediment from street around the storm inlet and place back onto lot behind perimeter controls. Complete repairs before the next anticipated rain and by no later than one week from the day they are noted.